

Agilent PNA Microwave Network Analyzers

Application Note 1408-12

Pulsed-RF S-Parameter Measurements Using Wideband and Narrowband Detection

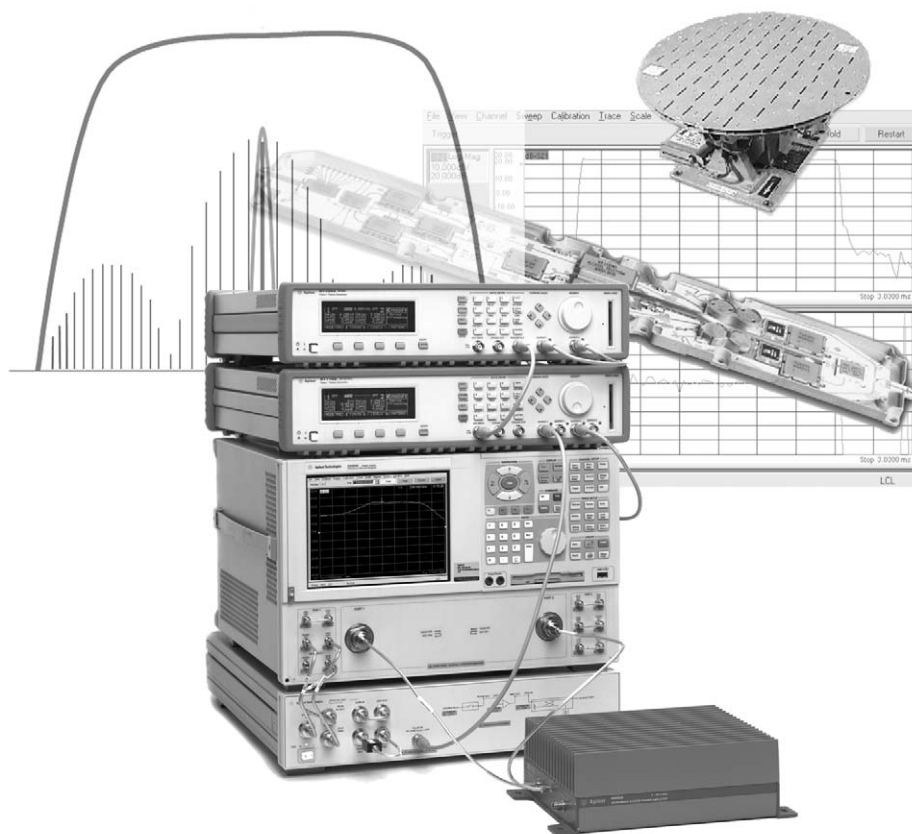

Agilent Technologies

Table of Contents

Introduction	3
Pulsed-RF measurement types	5
Average and point-in-pulse pulse measurements	6
Pulse profile measurements	7
Pulse-to-pulse measurements	8
Pulsed-RF Detection Techniques	9
Overview of wideband detection	10
Overview of narrowband detection	11
Comparing the two techniques	12
In-depth view of wideband detection	13
In-depth view of narrowband detection	20
Using spectral nulling for wider IF bandwidths	24
Typical setup for forward pulsed-RF amplifier measurements	30
Pulling it all together with Option H08	32
More Configuration Choices	34
Hardware setups	34
Reference signal choices	37
Pulse test sets	38
Pulse generators	39
IF gain setting	40
Reference loop	40
Measuring frequency converters	40
Using power sweeps	40
Calibration	41
S-parameter measurements	41
Source power calibration	41
Comparing the PNA and 8510	43
Summary	47
Web Resources	48

Introduction

Vector network analyzers are the primary tool for accurate characterization of RF and microwave components, providing precision measurements of both magnitude and phase responses. For many devices, a continuous-wave (CW) stimulus/response configuration is sufficient.

However, many RF and microwave amplifiers used in commercial and aerospace/defense applications require testing using a pulsed-RF stimulus. This application note focuses on new pulsed-RF S-parameter measurement techniques and capability provided by Agilent's PNA Series of microwave vector network analyzers. This application note discusses the advantages and disadvantages of the two detection techniques commonly used (wideband and narrowband detection), and compares and contrasts the PNA series network analyzers (including the PNA-L) with the former industry standard for pulsed S-parameter measurements, the 85108A pulsed RF-network analyzer system.

Figure 1 shows an example of a modern microwave system – in this case, a radar system. It is apparent from the block diagram that these systems are composed of many individual RF and microwave components, such as amplifiers, mixers, filters and antennas. Accurate magnitude and phase characterization of these components is critical for effective system simulation and verification. Some of these components can be tested with conventional swept-CW signals; this will yield traditional S-parameter measurements. However, some of the components must be tested under pulsed-RF conditions to simulate their intended operating environment. This application note covers the specific pulsed-RF measurements used most often and the techniques by which they are achieved.

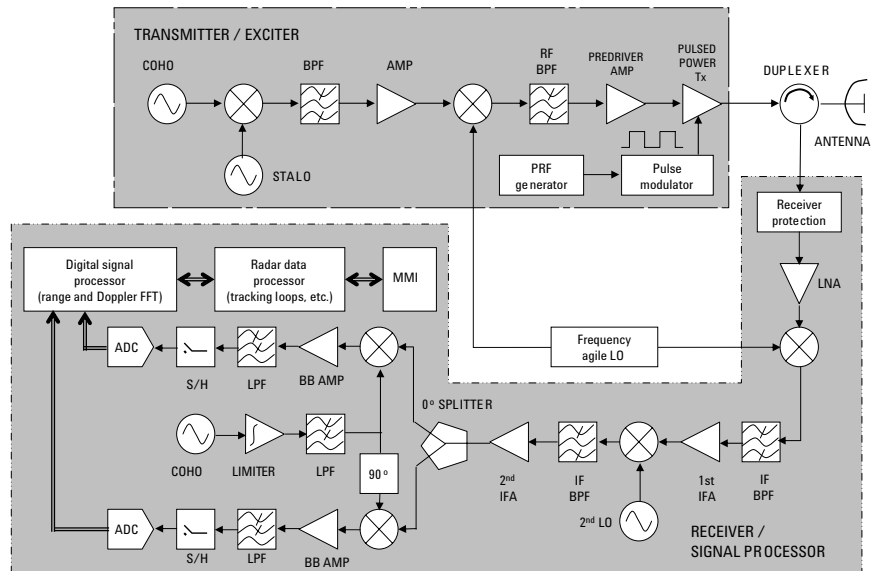

Figure 1. Block diagram of a typical radar system

Pulsed-RF component testing

The topic of pulsed-RF testing is often focused on measuring the pulses themselves. This is critical, for example, in evaluating radar system performance and effectiveness. When measuring components however, the pulses are merely the stimulus, and the vector network analyzer (VNA) measures the effect that the device under test (DUT) has on the pulsed stimulus. Any non-ideal behavior of the pulses themselves is removed from the measurement since the VNA performs ratioed measurements. This means that each S-parameter measurement compares a measured reflection or transmission response with the incident signal, providing ratioed magnitude and phase results. Figure 2, shows the configuration for measuring forward S-parameters: the R receiver measures the incident signal, the A receiver measures the reflection response, and the B receiver measures the transmission response. S11 is the complex ratio of the A and R receivers, and S21 is the complex ratio of the B and R receivers.

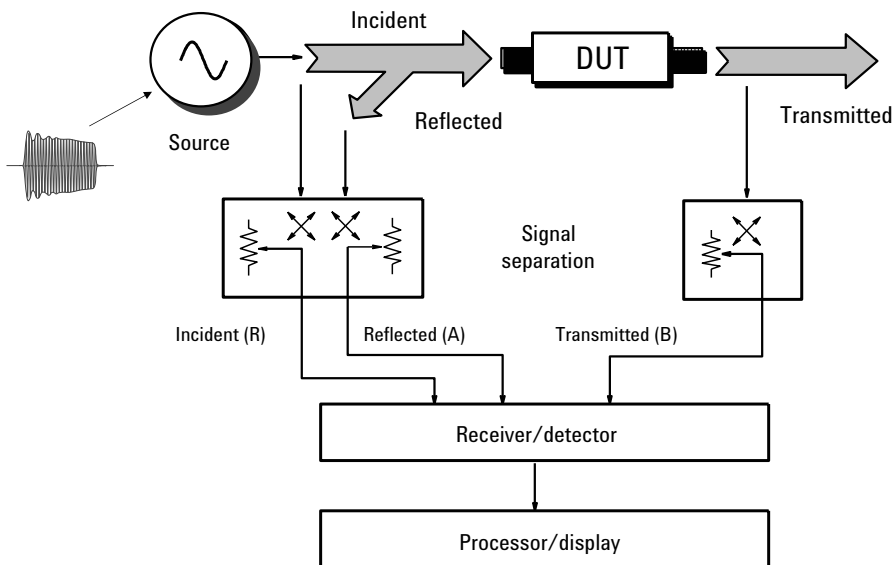

Figure 2. Simplified vector network analyzer block diagram

Testing under pulsed-RF conditions is very valuable for devices that will be used in a pulsed-RF environment, since the behavior of many components differs between CW and pulsed-stimulus test. For example, the bias of an amplifier might change during a pulse. Or, the amplifier might exhibit overshoot, ringing, or droop as a result of being stimulated with a pulse. Also, particularly for radar systems, measuring the transient behavior within the pulse is critical for understanding system operation. Unintended modulation on the pulse (UMOP) can cause system problems in radar systems such as decreased clutter rejection, decreased target velocity resolution, undesired spread of phased-array-antenna beam patterns, and unintentional identification of radar systems. Characterizing the amplitude and phase versus time in the pulse is crucial to characterizing and containing UMOP.

Many devices simply cannot be tested with CW stimulus at the desired power levels. For example, many high-power amplifiers are not designed to handle the power dissipation of continuous operation, and when testing on-wafer, many devices lack sufficient heat sinking for CW testing. Testing with pulses allows the test-power levels of these devices to be consistent with actual operation, resulting in more realistic characterization without thermal-induced damage. Characterizing these devices on-wafer prevents devices which don't meet their specifications from being packaged, saving the manufacturer considerable time and money.

Pulsed-RF measurement types

This section covers the four basic ways that pulsed-RF stimuli are used in conjunction with VNAs. The first two types are pulsed S-parameter measurements, where a single complex data point is acquired for each carrier frequency. The data is displayed in the frequency domain as magnitude and/or phase of transmission and reflection (Figure 3). The third and fourth measurement types are done with a fixed-RF carrier, and display data in the time domain.

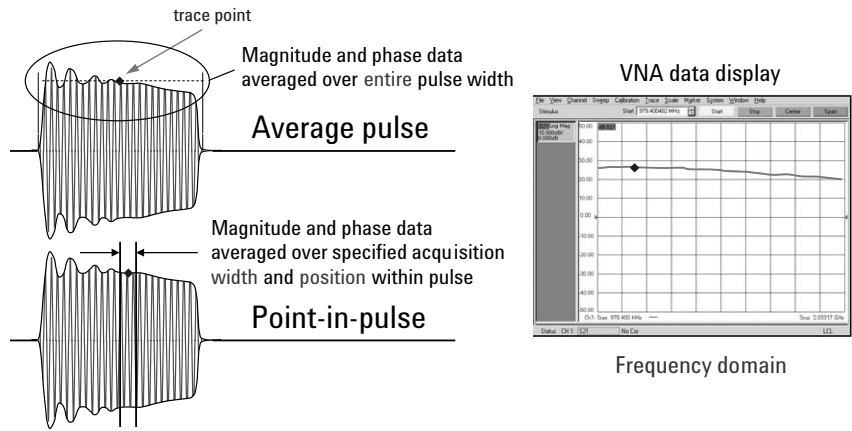

Figure 3. Average and point-in-pulse measurements

Average and point-in-pulse measurements

Average pulse measurements make no attempt to position the trace point at a specific point within the pulse. For each carrier frequency, the displayed S-parameter represents the average value of the pulse. This occurs for example when doing narrowband detection without any receiver gating. Point-in-pulse measurements result from taking data only during a specified acquisition window within the pulse. This window must be specified in terms of time duration (width) and position within the pulse (delay). There are different ways to do this in hardware, depending on the type of detection used (Figure 4). With wideband detection, the window is generally set by the data sampling period (determined by the IF bandwidth of the instrument) and a specified delay. With narrowband detection the acquisition window is set with a hardware switch or "gate", which only allows measurement of a slice of each pulse. The gating can be performed in either the RF or IF portion of the measurement receiver (PNA Option H11 provides IF gates). Both wideband and narrowband point-in-pulse techniques will be covered in depth later on.

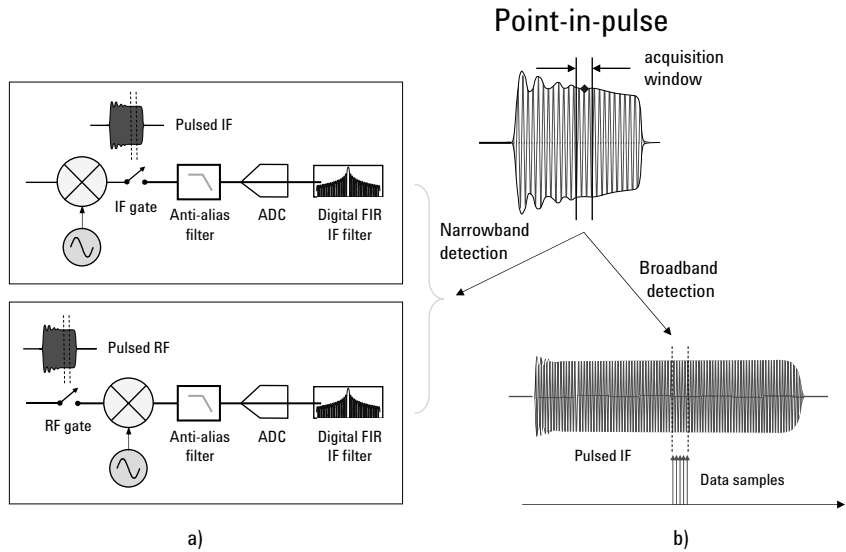

Figure 4. a) Narrowband detection uses hardware switches (gates) in the RF or IF path to define the acquisition window. b) Broadband detection uses the sampling period to define the acquisition window.

Pulse profile measurements

Pulse profile measurements (Figure 5) display the magnitude and phase of the pulse versus time, instead of frequency. The data is acquired at uniformly spaced time positions across the pulse. This is achieved by varying the delay of measurement with respect to the pulse while the carrier frequency is fixed at some desired frequency.

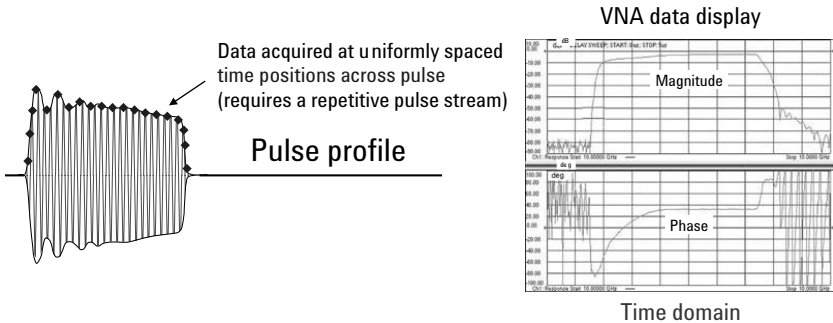

Figure 5. Pulse profile measurements

For all of these measurements, there may not be a one-to-one correlation between trace points and the actual number of pulses that occur during the course of the entire measurement. For example, with narrowband detection, many pulses can occur before enough data is collected for each trace point. With wideband detection, the analyzer may not be able to completely process a trace point during the time between pulses, resulting in skipped pulses between displayed trace points.

Figure 6 shows in more detail how the data acquisition occurs for point-in-pulse and pulse-profile measurements. This example shows 6 pulses required for every trace point, but actually the number of pulses needed varies with pulse-repetition frequency (PRF) and IF bandwidth, and ranges from one (using wideband detection) to many (using narrowband detection). The differences between the detection modes is explained starting on page 9. For point-in-pulse measurements, the gate position is constant (relative to the pulse trigger) for all the pulses, regardless of carrier frequency. Each successive trace point represents a higher carrier frequency. For pulse-profile measurements, the gate position is constant only during the time it takes to measure one trace point. For each successive trace point, the gate delay is increased, so that after all the trace points are acquired, the delay will have spanned the range set up in the pulse-profile measurement.

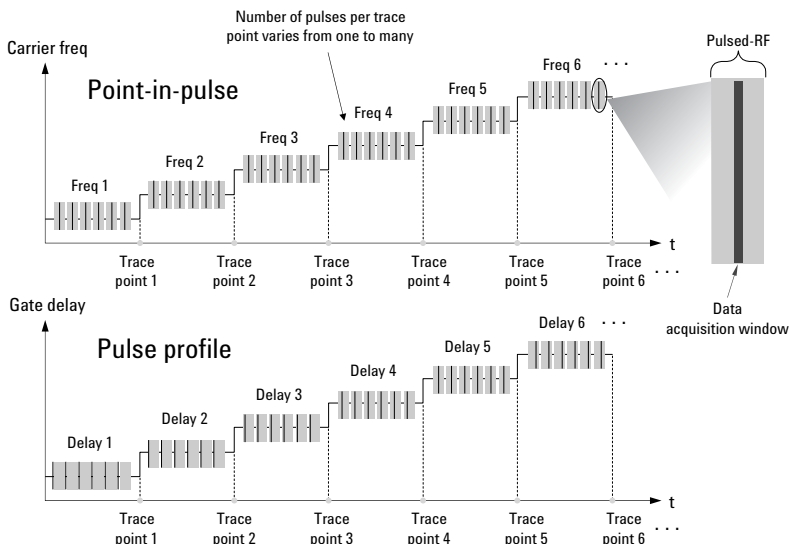

Figure 6. Pulsed-RF data acquisition (time-domain view)

Pulse-to-pulse measurements

Pulse-to-pulse measurements are used to characterize how a pulse stream changes versus time due to variations in the performance of the DUT. For example, thermal effects in an amplifier can cause gain reduction and phase shifts. These measurements are done with a fixed RF carrier, and the data is displayed as either magnitude or phase versus time. The measurement point remains fixed in time with respect to a pulse trigger. Figure 7 shows an example of a pulse stream decreasing in magnitude over the course of six pulses, due to gain reduction in a high-power amplifier as it heats up.

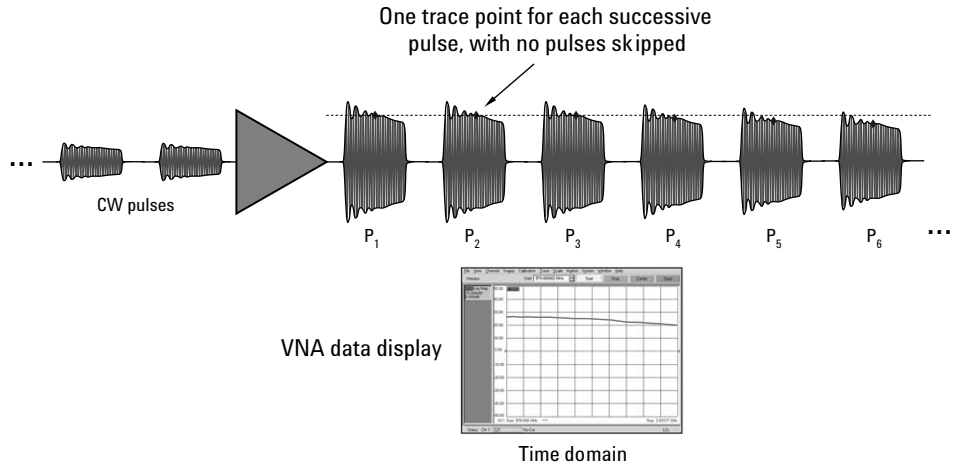

Figure 7. Pulse-to-pulse (single shot) measurements

Pulse-to-pulse measurements require wideband detection, and the data processing in the analyzer must be fast enough to keep up with the pulses. There must be one trace point per RF pulse, and no pulses can be skipped. Since pulse-to-pulse measurements can capture information from a non-repetitive pulse stream, the measurement falls under the general category of "single-shot" (as opposed to repetitive) measurements.

Pulsed-RF Detection Techniques

The next section provides an overview of the two different detection techniques, wideband and narrowband, commonly used in network analyzers. Each detection technique has its advantages and disadvantages. However, either technique can be used to accurately measure S-parameters of amplifiers.

This application note assumes the reader is already familiar with pulsed-RF measurements. The basic concepts of pulsed RF are reviewed in Figure 8. When a signal is switched on and off in the time domain (i.e., “pulsed”), the signal’s spectrum in the frequency domain has a $\text{sin}(x)/x$ response. The widths of the lobes are inversely related to the pulse width (PW). This means that as the pulses get shorter in duration, the spectral energy is spread across a wider bandwidth. The spacing between the various spectral components is equal to the pulse repetition frequency (PRF). If the PRF is 10 kHz, then the spacing of the spectral components is 10 kHz. In the time domain, the repetition of pulses is expressed as pulse repetition interval (PRI) or pulse repetition period (PRP), which are two terms for the same thing.

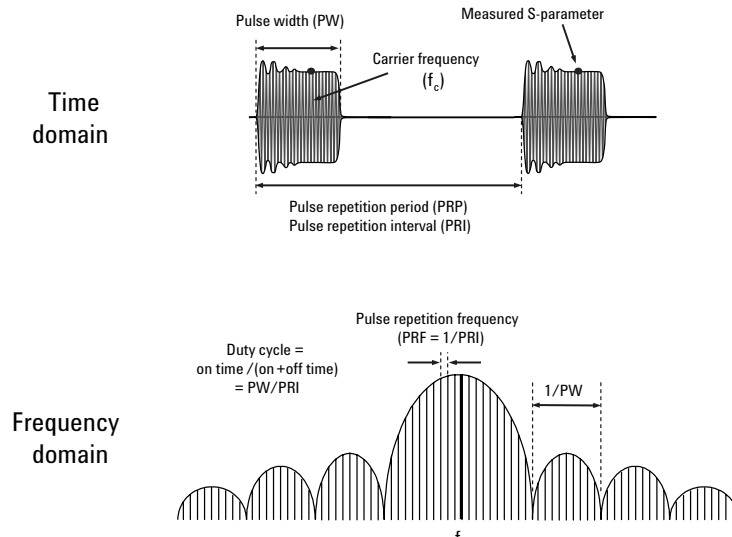

Figure 8. Pulsed-RF network-analysis terminology

Another important measure of a pulsed RF signal is its duty cycle. This is the amount of time the pulse is on, compared to the period of the pulses. A duty cycle of 1.0 (100%) would be a CW signal. A duty cycle of 0.1 (10%) means that the pulse is on for one-tenth of the overall pulse period. For a fixed pulse width, increasing the PRF will increase the duty cycle. For a fixed PRF, increasing the pulse width increases the duty cycle. Duty cycle is an important pulse parameter for narrowband detection.

Overview of wideband detection

Wideband detection can be used when the majority of the pulsed-RF spectrum is within the bandwidth of the receiver, as shown in Figure 9. In this case, the pulsed-RF signal will be demodulated in the instrument, producing baseband pulses. This detection can be accomplished with analog circuitry or with digital-signal processing (DSP) techniques. With wideband detection, the analyzer must be synchronized with the pulse stream, so that data acquisition only occurs when the pulse is in the “on” state. This means that a pulse trigger must be supplied to the analyzer that is the same frequency as the PRF, and that has the correct delay relative to the pulse stream. For this reason, this technique is also called synchronous acquisition mode. 8510-based systems had a built-in pulse generator to synchronize the data acquisition, while the PNA relies on external pulse generators.

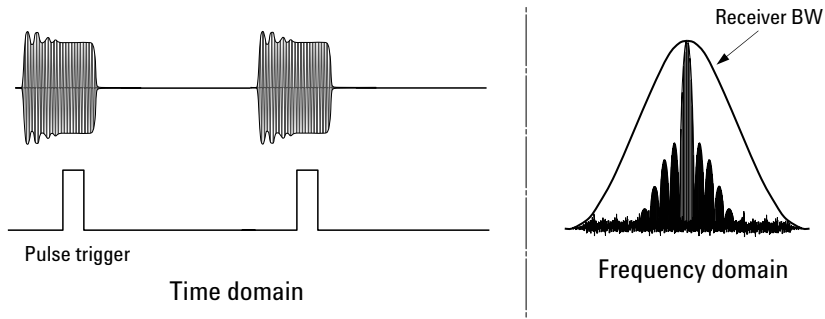

Figure 9. Wideband (synchronous) detection

The advantages of the wideband mode are the fast measurement speed, simplicity of the test setup, and that there is no loss in dynamic range when the pulses have a low duty cycle (i.e., a long time interval between pulses). Measurements take longer as duty cycle decreases, but since the analyzer is always sampling when the pulse is on, the signal-to-noise ratio is essentially constant versus duty cycle.

There are two disadvantages to using wideband detection. The first is that, compared to narrowband detection, the noise floor of the instrument is higher due to the wider IF bandwidth used for detection. In the 8510, for example, this limited the best-case dynamic range to approximately 60 dB. Another disadvantage of this technique is that there is a lower limit to measurable pulse widths. As the pulse width gets smaller, the spectral energy spreads out—once enough of the energy is outside the bandwidth of the receiver, the instrument cannot detect the pulses properly. Another way to think about it in the time domain is that when the pulses are significantly shorter than the rise time of the receiver, they cannot be detected. In the 8510, the narrowest pulse width that could be used was about 1 μ s.

Generally, if the pulse width required for testing the DUT is long enough to use wideband detection, it is the preferred method.

Overview of narrowband detection

Narrowband detection is used when the bandwidth of the receiver is too small to contain the significant energy of the pulsed-RF spectrum. Since the pulsed-RF signal cannot be fully captured, the analyzer goes to the other extreme: filter everything away except for one spectral component, as shown in Figure 10. With narrowband detection, all of the pulse spectrum is removed by analog or DSP-based filtering except for the central frequency component, which represents the frequency of the RF carrier. After filtering, the pulsed-RF signal appears as a sinusoidal (CW) signal, so there is no need to synchronize the analyzer samples with the incoming pulses, and a pulse acquisition trigger is not required. Because an acquisition trigger is not used for narrowband detection, the technique is also called asynchronous acquisition mode.

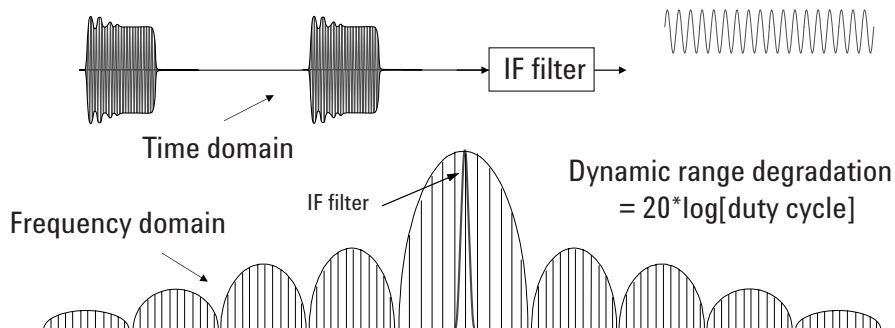

Figure 10. Narrowband (asynchronous) detection

Although a data acquisition trigger is not needed for narrowband detection, it should be noted that, when gating is employed, the gate switches do require a synchronous trigger so that the gate is turned on during some portion of the time when the pulse is also on. However, since gating is not an essential element of narrowband detection, the technique is still considered as an asynchronous process.

When older network analyzers like the 8510 use narrowband detection, the PRF has to be high compared to the IF bandwidth, to ensure that all of the undesired spectral components are filtered away. For this reason, the technique is also sometimes called the "high PRF" mode.

Agilent developed a unique "spectral-nulling" technique for the PNA which enables narrowband detection using wider IF bandwidths than normal. This novel technique yields faster measurements than those obtained by conventional narrowband filtering, and lets the user trade dynamic range for speed.

The main advantage to narrowband detection is that there is no lower pulse-width limit, since no matter how broad the pulse spectrum is, most of it is filtered away anyway, leaving only the central spectral component. For example, the PNA in narrowband mode can easily make S-parameter measurements with 100 ns pulses. Another advantage is that for duty cycles in the 1% to 100% range, measurement dynamic range is usually significantly better than that obtained from wideband detection, due to the narrower IF bandwidth filters that are used.

The disadvantage to narrowband detection is that measurement dynamic range decreases as duty cycle decreases. As the duty cycle of the pulses gets smaller (i.e., a longer time interval between pulses), the average power of the pulses gets smaller, resulting in less signal-to-noise ratio. In the frequency domain, you can see this effect by observing the magnitude of each spectral component decrease as duty cycle decreased, resulting in decreased measurement dynamic range. This phenomenon is often called "pulse desensitization". The degradation in dynamic range (in dB) can be expressed as $20 \cdot \log(\text{duty cycle})$.

Comparing the two techniques

Figure 11 shows the effect of duty cycle on pulsed dynamic range. The 8510, using broadband detection, has around 62 dB of dynamic range, independent of duty cycle. Using narrowband detection, the PNA's dynamic range decreases with decreasing duty cycle. For every factor of 10 decrease in duty cycle, the dynamic range is reduced by 20 dB. The cross-over point is approximately 0.1% — this means that for duty cycles of 0.1% or more, the PNA will have as much or more dynamic range than an 8510 system. This duty cycle range covers most radar, electronic warfare, and wireless communications measurement applications. The PNA's inherent high dynamic range (compared to the 8510) helps it overcome the limitations of narrowband detection. Also, the PNA has the advantage of being able to measure components needing pulses narrower than 1 us, which is the 8510's limit.

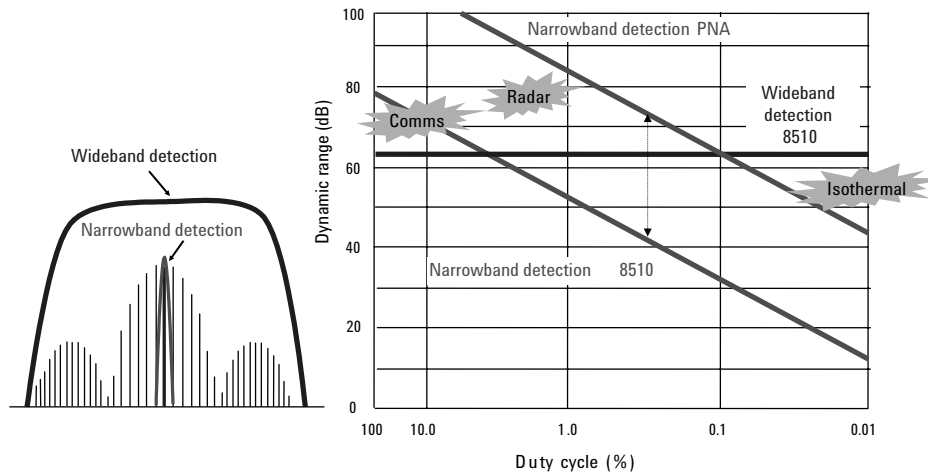

Figure 11. Duty-cycle effect on pulsed dynamic range

Note that the x-axis of this chart is the system duty cycle, which takes into account any gating that the PNA uses for point-in-pulse or pulse-profiling measurements. If the gate is such that only one-fifth of each incoming pulse is measured, then the overall duty cycle is effectively reduced by a factor of 5.

In summary, wideband detection offers dynamic range independent of duty cycle, but there is a limit to how narrow the pulsed stimulus can be. Narrowband detection has no lower pulse-width limit, but measurement dynamic range is proportional to duty cycle. For the pulse widths and repetition frequencies used in many radar applications, the PNA using narrowband detection offers faster measurement speeds and more dynamic range than the 8510 using wideband detection.

In-depth view of wideband detection

This section compares how the 8510 and PNA hardware and firmware implement wideband detection. Figure 12 shows a simplified block diagram of the IF portion of an 85108 (8510-based) pulsed-RF system. The incoming 20 MHz pulsed-IF signal is mixed with a 20 MHz local oscillator to produce baseband I/Q pulses (this technique is called synchronous detection). The detection bandwidth is about 1.5 MHz for the I and Q outputs, which is equivalent to a 3 MHz pre-detection bandwidth. This bandwidth yields pulses that have about a 300 ns rise time ($1/\tau$). The pulse width must be greater than several τ 's in order for the detector to fully respond to the pulses. Due to the bandwidth of the analog detector, the specified minimum pulse width for the 85108 is 1 μ s, but in practice, the pulse width can be pushed down to perhaps 500 ns or so.

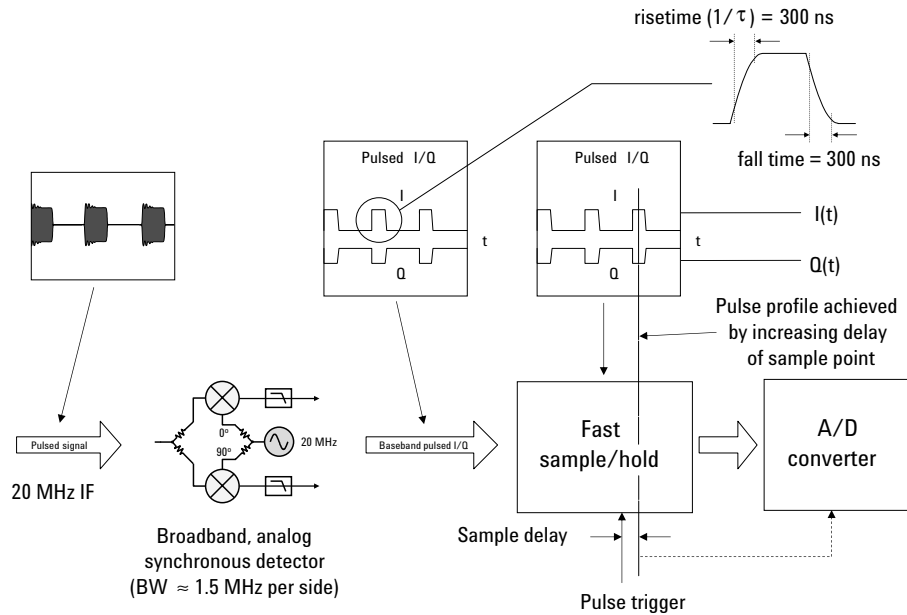
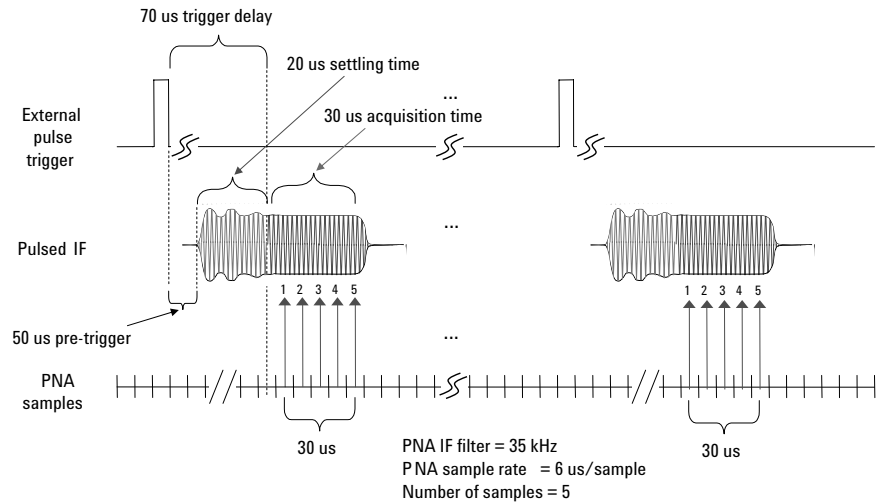

Figure 12. Time-domain view of wideband detection in the 85108 pulsed-RF system

After the pulses are detected, a fast sample-and-hold circuit is used prior to the relatively slow (by today's standards) analog-to-digital converter (ADC). Once the pulses are digitized, magnitude and phase is calculated. The actual sample point can be programmed with any arbitrary delay with respect to the pulse trigger. The user specifies this delay value to accomplish point-in-pulse measurements. Pulse profiling is achieved by stepping the sample delay from arbitrary start and stop values to cover the duration of the pulse.

Figure 13 is a conceptual block diagram of how the PNA achieves wideband detection. Since all of the PNA's IF processing (filtering and detection) is done with DSP, the incoming pulsed-IF signal is sampled directly. To get one filtered trace point using the 35 kHz IF bandwidth of the PNA, five data samples are required (more on this later), which requires 30 us of acquisition time (6 us per sample). However, due to the IF settling time, the pulse must be present about 20 us prior to sampling. This yields a minimum pulse width of about 50 us. To achieve this value, the "auto-IF-gain" mode of the PNA's receivers must be turned off, and the IF gain must be set manually. This should be done empirically – the higher the IF gain, the better the dynamic range of the measurement, but care should be taken to ensure that the PNA's receivers are not in compression.



Using the PNA:

20 us settling + 30 us acquisition = 50 us minimum pulse width (using 35 kHz IF bandwidth)

Figure 13. Time-domain view of wideband detection in the PNA

Note that the trigger delay of the PNA (the time between the external pulse trigger and when the PNA actually takes data) is about 70 us. This means the PNA must be triggered about 50 us before the pulse modulator is triggered. This 50 us of "pre-trigger" plus the 20 us IF settling time gives 70 us.

The PNA-L, a lower-cost version of the PNA, can also perform wideband pulse detection. The PNA-L has a wider maximum IF bandwidth than the PNA, allowing wideband detection to work with pulses as narrow as 10 us or 2 us, depending on the model (see Figure 14). The "auto-IF-gain" mode must also be turned off to improve the IF settling time. Note that, unlike the PNA, the PNA-L cannot use narrowband detection with spectral nulling. The next section discusses narrowband detection for the PNA in more detail.

	Maximum IF bandwidth	Minimum pulse width	IF auto-gain mode available?*
PNA models (20, 40, 50, 67 GHz)	40 kHz	50 us	Yes
PNA-L models (2-port, 20, 40, 50 GHz)	250 kHz	10 us	Yes
PNA-L models (2-port, 6, 13.5 GHz; 4-port, 20 GHz)	600 kHz	2 us	No

* Note: for pulsed-RF measurements, the IF auto-gain mode should be turned off (i.e., set IF gains manually)

Figure 14. PNA and PNA-L minimum pulse widths for wideband detection

Figure 15 shows a longer pulse than that shown in Figure 13, illustrating how the PNA can perform point-in-pulse and pulse-profile measurements using wideband detection. The user specifies the position in the pulse where data is acquired by setting the delay of the PNA point trigger relative to the RF modulation trigger. The width of the acquisition window (which determines the resolution of the point-in-pulse or pulse-profile measurement) is determined by the PNA's IF bandwidth. Using the 35 kHz (recommended) IF bandwidth on the PNA, the smallest resolution that can be achieved using wideband detection is 30 us. As you will see in the next section, narrowband detection and IF gates can provide much higher resolution (20 ns or better).

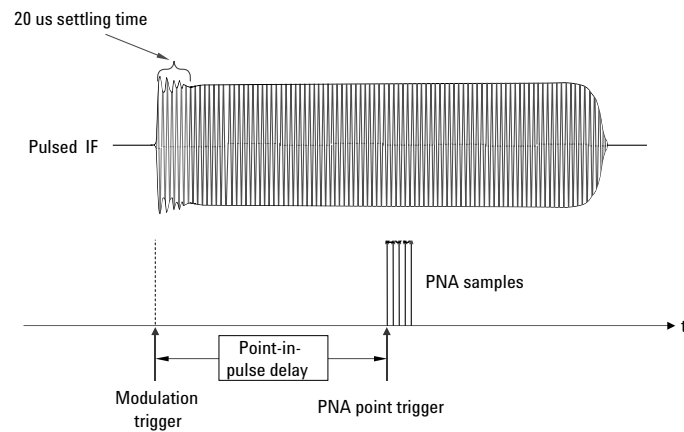

Figure 15. Point-in-pulse measurements in the PNA using wideband detection

Figure 16 shows a typical PNA setup for making wideband pulsed-RF measurements. This configuration can be used for pulse-to-pulse measurements or for point-in-pulse measurements, when the pulse width is sufficiently wide. In this example, the pulse generator sets the overall pulse timing. The PNA's trigger must be set as follows:

Trigger Source = External
Trigger Scope = Channel
Channel Trigger State = Point Sweep

Under External Trigger:
Input Source = TRIG IN BNC
Level = Positive or Negative Edge

Besides setting the auto-IF-gain to off, the PNA's sweep should be set to step-sweep mode, and the frequency-offset mode should be turned on with an offset of zero Hz. This ensures the PNA's source will remain phase-locked in the presence of a pulsed-RF reference signal.

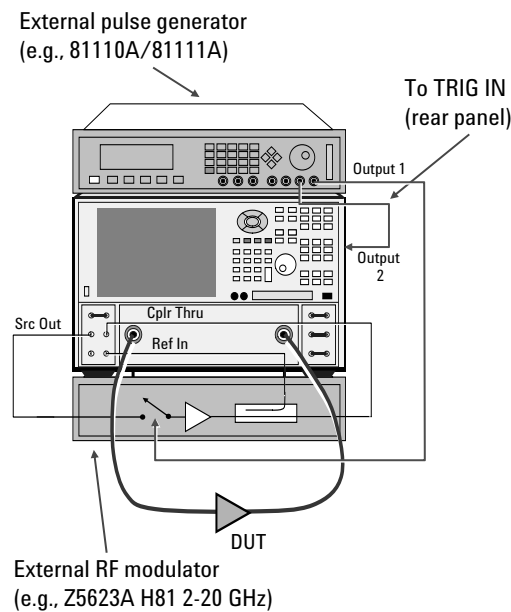

Figure 16. Typical PNA hardware setup for wideband detection

Note that the IF gates included in Option H11 are not needed for wideband detection, since point-in-pulse measurements are done by adjusting the pulse delay of the trigger signal to achieve acquisition at the desired point in time, instead of using RF or IF gates as required when using narrowband detection. Wideband measurements also do not require Option H08, which is the pulse software application used for narrowband detection. For point-in-pulse measurements, which essentially are S-parameter measurements, the start and stop frequencies must be set up to the proper values. For pulse-to-pulse measurements, the PNA is set up in CW-time mode. In this case, each trace point is a subsequent pulse, and all pulses have the same carrier frequency. The minimum PRI that the PNA can keep up with without missing pulses depends on which PNA or PNA-L is used, and is summarized in Figure 17.

PNA conditions: point sweep, external trigger, CW sweep, IF auto-gain = off	Maximum IF bandwidth	Minimum PRI	Maximum PRF
PNA models (20, 40, 50, 67 GHz)	40 kHz	170 us	5.9 kHz
PNA-L models (2-port, 20, 40, 50 GHz)	250 kHz	80 us	12.5 kHz
PNA-L models (2-port, 6, 13.5 GHz; 4-port, 20 GHz)	600 kHz	40 us	25 kHz

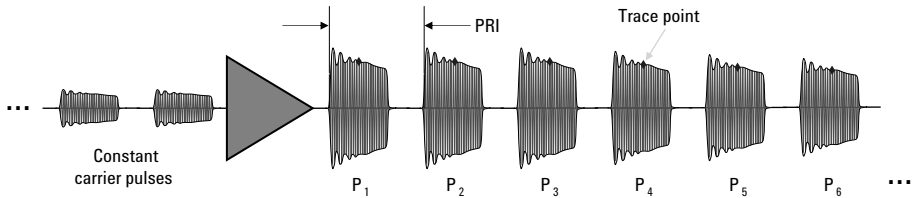
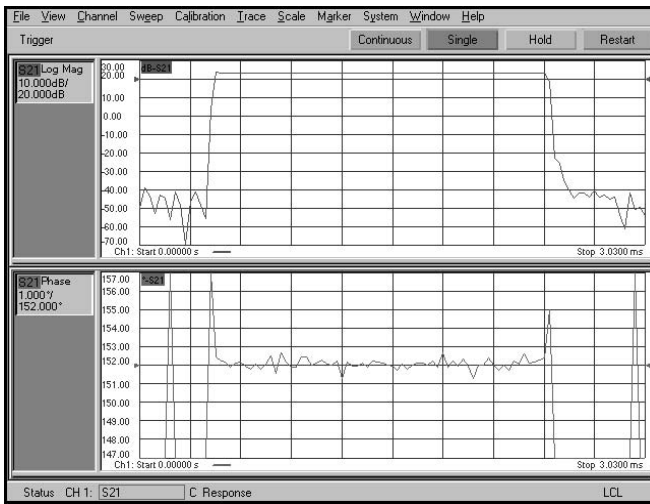

Figure 17. Fastest PRI and PRF values for pulse-to-pulse measurements using wideband detection

Figure 18 is an example of pulse profiling using wideband detection with the PNA. For this measurement, the PNA uses the same external trigger setup as described above, except the point-sweep mode should be unselected. The external trigger is used to start the measurement, and then the PNA takes data as fast as it can (see the timing diagram in Figure 19). There is no need to increment the delay of the trigger as was done with the 8510. Note that for n-points, the pulse must be longer than n times the PNA’s data-point acquisition time. This results in a minimum measurable pulse width that is much longer than the minimum pulse width that can be used for point-in-pulse measurements, where the pulse must only be longer than one times the PNA’s data-acquisition time (plus a bit extra for IF settling time). Figure 20 shows the minimum pulse width for pulse-profile measurements versus the number of measurement points for various PNA and PNA-L models.



PW = 2 ms
 PRF = 50 Hz
 Duty cycle = 10%
 Points = 101
 IF BW = 35 kHz

Figure 18. Pulse profile measurements in the PNA using wideband detection

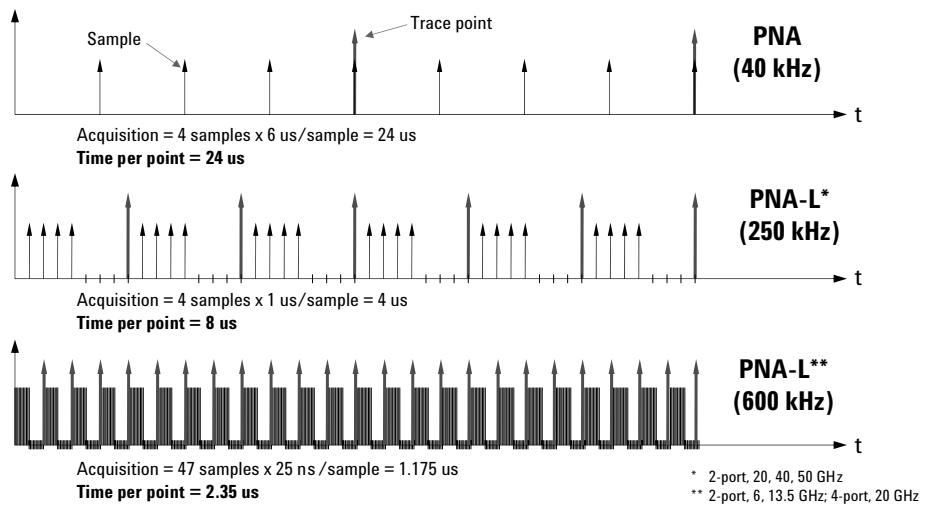
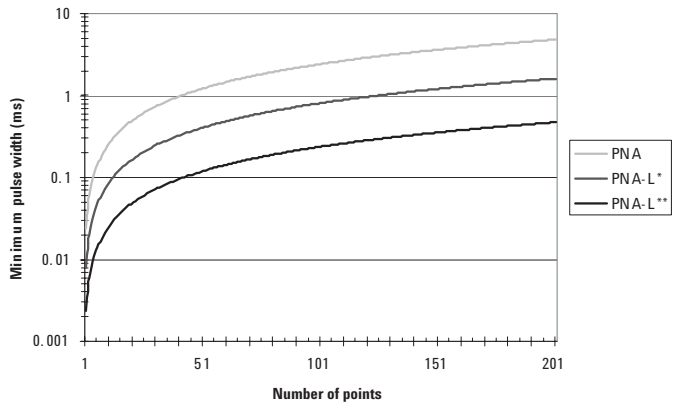

Figure 19. Data acquisition for pulse profiling using the widest bandwidths of various PNA and PNA-L models



* PNA-L 2-port, 20, 40, 50 GHz
 ** PNA-L 2-port, 6, 13.5 GHz; 4-port 20 GHz

Figure 20. Minimum pulse width for pulse-profile measurements for various PNA and PNA-L models

Figure 21 shows the importance of setting the proper trigger-delay value for the measurement, to achieve accurate point-in-pulse measurements. When the PNA's data acquisition is not properly positioned within the pulse, you see either pure noise, or a noisy response that is smaller than the true response. The correct trigger delay setting is generally derived empirically. The trigger delay can be set using the PNA's trigger-delay feature, or via the pulse generator's timing. Note that most pulse generators have more timing resolution for the delay setting than can be achieved using the PNA's trigger-delay feature.

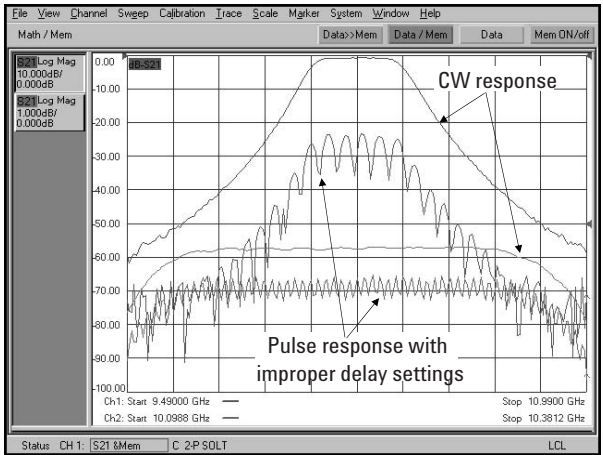

PRF = 4 kHz
 Width = 50 us
 PNA IF BW = 35 kHz

Note:
 The lower traces have a narrower span and a more sensitive scale than the upper traces.

Figure 21. Example traces showing proper and improper trigger-delay settings for wideband detection

In-depth view of narrowband detection

This section focuses exclusively on the PNA and its unique “spectral nulling” technique for narrowband detection. Spectral nulling allows the use of wider bandwidths, improving measurement speed (typically by a factor of 10 or more).

To understand how the spectral nulling works with narrowband detection, the pulsed-RF signal with a 1.7 kHz PRF shown in Figure 22 will be used as an example. Figure 23 shows a “zoomed-in” view around the central spectral component, which is shown in the “zero” or center position of the figure, since the pulsed-RF signal has been normalized to the carrier frequency in this example. Due to the 1.7 kHz PRF, you expect to see spectral components on either side of the carrier at intervals of 1.7 kHz. Only the first adjacent spectral components are shown in the figure. There are thousands of other spectral components present that are beyond the scale of the figure.

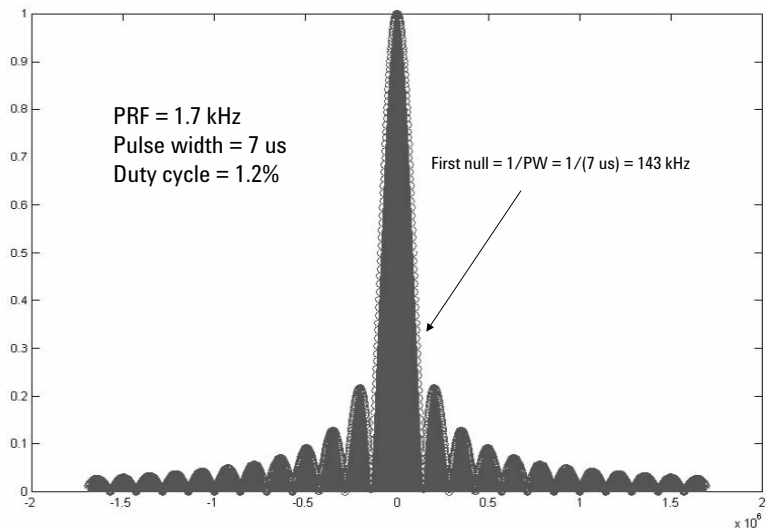

Figure 22. Pulsed-RF spectrum of narrowband measurement example

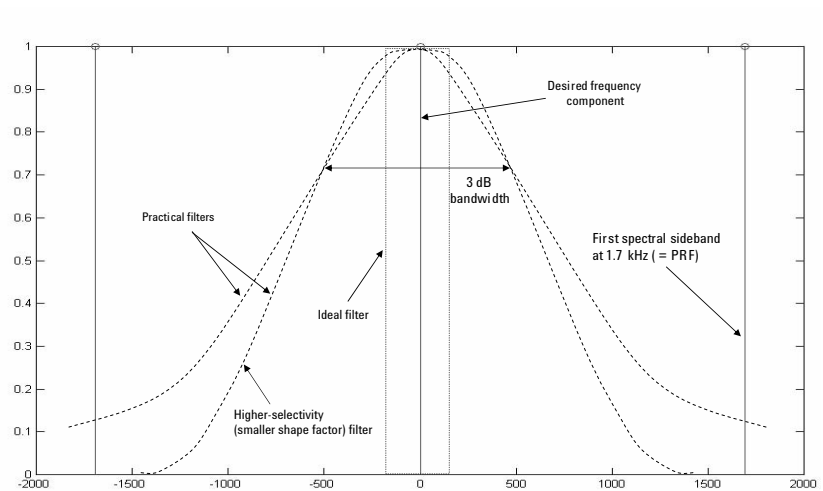
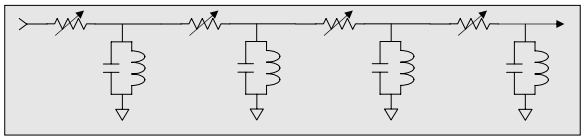

Figure 23. A zoomed-in view of the example pulse spectrum showing ideal and practical filter responses

If you could build an ideal filter to select the central spectral component but filter away everything else, it would look like a rectangle centered at zero Hz. A practical filter however requires a transition region between the passband and stopband. Typically, the stopband must be attenuated by 70 dB or more to filter out undesired spectral components and achieve sufficient measurement dynamic range. This means that the 3 dB bandwidth of the filter must be some fraction of the PRF. The value of the fraction depends on the selectivity of the filter. The selectivity is often expressed as shape factor, which is the ratio of the 60 dB bandwidth divided by the 3 dB bandwidth. The smaller the shape factor, the faster the filter rolls off, and the wider the IF bandwidth that can be used for narrow-band detection. The figure shows that for a given 3 dB bandwidth, filters with different shape factors will roll off at different rates.

Narrowband detection can be accomplished either with analog or digital filtering, as shown in Figure 24. To accommodate a wide range of PRFs, variable bandwidth filters are very desirable to optimize measurement speed. The classic way to implement an analog, variable-bandwidth IF filter is by using the synchronously tuned topology. The heart of the filter is a parallel LC (inductor/capacitor) resonator driven by a variable series resistance, usually achieved with a PIN diode. As the series resistance is increased, the bandwidth of the filter section gets smaller. Concatenating multiple resonator stages increases the selectivity of the filter.

Classic analog variable-bandwidth bandpass filter:



Digital filtering: digital-signal processing after analog-to-digital conversion

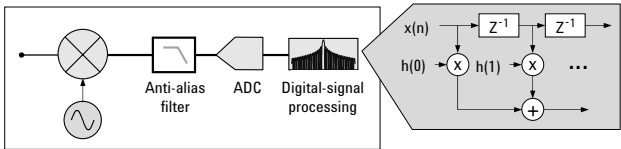

Figure 24. Analog versus digital filtering

Variable-bandwidth digital filters are done using DSP algorithms performed after an analog-to-digital conversion occurs. There are two basic types of digital filters: finite-impulse response (FIR) and infinite-impulse response (IIR). The topologies of these two filters differ, and each has their advantages and disadvantages. The bandwidth and selectivity (shape factor) of digital filters are controlled by the filter topology, number of delay elements, and weighting factors.

So, how wide a filter can the PNA use to successfully perform narrowband detection? To answer that question, you need to understand a little more how the PNA’s digital IF filters work.

The PNA's IF filters are implemented as FIR filters. Figure 25 shows an example FIR topology. The number of filter sections or "taps" (M) is variable, depending on the IF bandwidth. The narrower the bandwidth, the larger the required number of filter sections. M is also the minimum number of ADC samples required to produce one trace point. As the filter bandwidth narrows, more samples are required, resulting in longer measurement times. The table in Figure 25 shows M (the number of sections and the number of samples required) for each of the PNA's standard IF filter bandwidths. Once enough samples are taken to produce a trace point, the analyzer steps to the next point, which would be a new carrier frequency for point-in-pulse measurements, or a new delay value for pulse profiling. The tap weightings (filter coefficients) $h(n)$ control the shape factor or selectivity of the filter. In order to implement the "spectral nulling" technique, it will be necessary to create non-standard or custom IF filters, with M values that fall between those listed in the table.

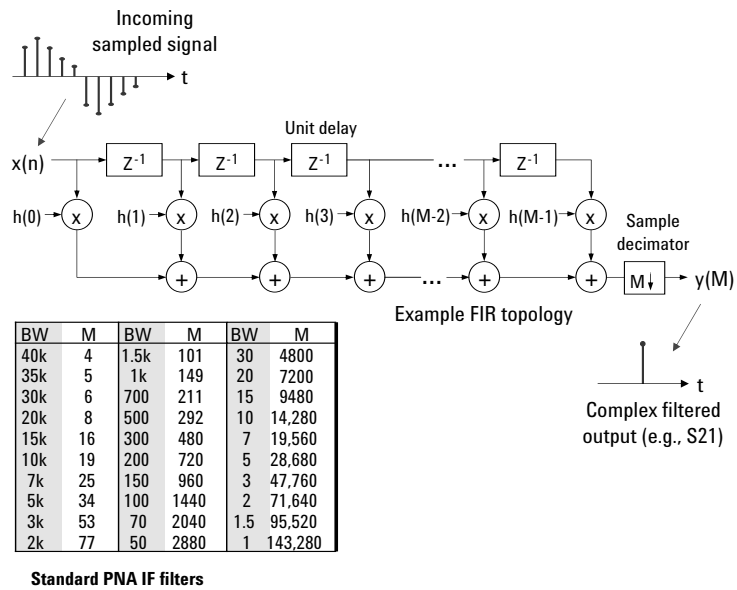

Figure 25. Finite impulse response (FIR) filter basics

Now that you know more about the digital filters in the PNA, you can look at their selectivity. Figure 26 shows two of the PNA's standard filters in the frequency domain. It is clear that these are not ideal rectangular filters. The 100 Hz filter on the left requires ± 50 kHz to achieve stopband attenuation of 75 dB. Using the filter without any "tricks" (like spectral nulling) means the PRF must be 50 kHz or greater to ensure that the unwanted spectral components are sufficiently filtered. In this case, the IF bandwidth would be 0.2% of the PRF. The shape factor of the 100 Hz filter is 400, compared to a typical spectrum-analyzer digital-filter shape factor of about 4. For the 10 kHz filter, the PRF would have to be greater than 2.5 MHz to ensure that the unwanted spectral components are sufficiently filtered. In this case, the IF bandwidth would be 0.4% of the PRF. The shape factor of the 10 kHz filter is 67, which is better than the 100 Hz filter, but is still far less selective than the filters on a spectrum analyzer. So, the standard IF filters, if used in a conventional manner, are not particularly well suited for narrowband pulse detection, as the IF bandwidths must be very narrow compared to the PRF (typically between 1% and 0.1% of the PRF), resulting in slow measurements. VNA digital filters are not optimized for selectivity (as are spectrum analyzer filters), because for S-parameter measurements, the filter is always exactly tuned to the incoming signal, or stated another way, the IF signal always falls in the center of the filter. With tracking filters, good selectivity is not needed. Instead, VNA filters are optimized for sweep speed and low noise bandwidth.

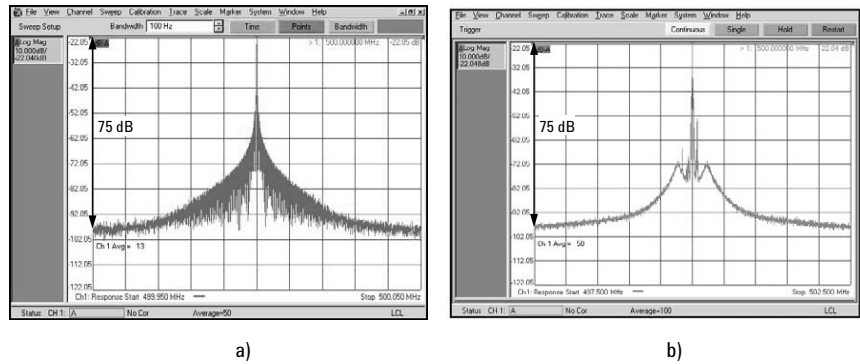

Figure 26. PNA IF filter shapes. a) 100 Hz filter with 100 kHz span. Shape factor = 400 b) 10 kHz filter with 5 MHz span. Shape factor = 67

Using spectral nulling for wider IF bandwidths

But wait! The story doesn't end here. There are attributes of the digital IF filters in the PNA that allow you to improve our measurement speed significantly. Figure 27 shows a typical narrowband filter on the PNA (500 Hz in this case). If you look near the center of the filter response on the linear-magnitude trace, you will notice something very interesting. There appear to be nulls in the frequency response at periodic intervals. If you display the filter response with a log-magnitude format, the frequency nulls are quite clearly seen. The frequency interval between nulls is directly proportional to the IF bandwidth, which in turn is inversely proportional to the number of sections of the digital filter, M . Note that the peaks of the filter response cause the poor selectivity seen in the previous figure. Figure 28 shows how to take advantage of these nulls.

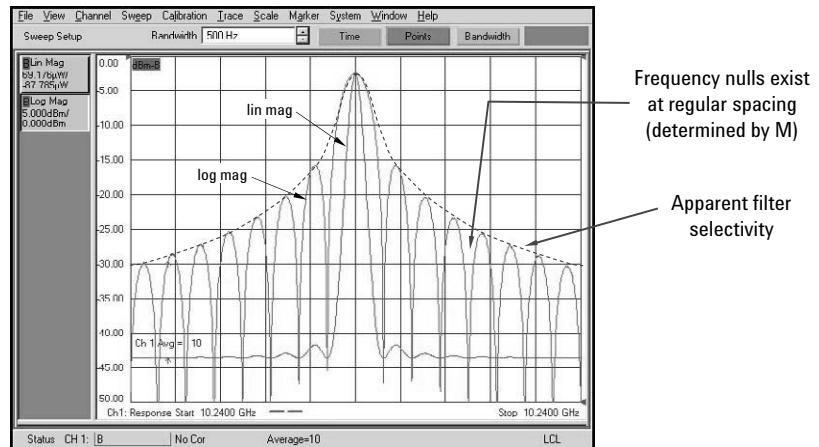

Figure 27. Close in view of the 500 Hz PNA IF filter

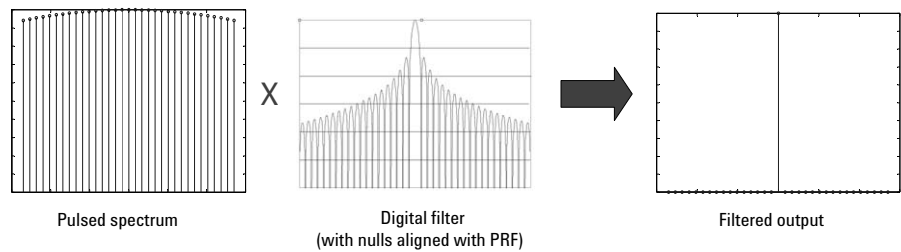

Figure 28. Filtered output using spectral nulling

If the number of filter sections can be chosen such that the filter's frequency nulls exactly align with the PRF, then the undesired pulsed spectral components will be filtered away, leaving the desired center spectral component. PNA Option H08 allows these custom IF filters to be created. Instead of the standard 1, 1.5, 2, 3, 5, 7, 10 filter sequence, you can construct IF filters with arbitrary bandwidths like 421 Hz or 87 Hz. The bandwidth of these filters must be chosen based on the PRF, to ensure proper spectral nulling. With this technique, the IF bandwidth can be much higher compared to the conventional filtering shown previously, resulting in much faster measurement speed. In practice, if a really wide bandwidth is desired, the PRF of the pulses may need to be adjusted slightly to ensure proper nulling. If the PRF cannot be adjusted, then the IF chosen will be as narrow as necessary to achieve proper spectral nulling.

Figure 29 shows the 500 Hz filter of Figure 27 superimposed on a 1.7 kHz PRF pulse stream. In this case the PNA is actually using every third null of the filter. This represents an IF bandwidth that is 29% of the PRF, instead of the 0.1 % to 1% required with conventional filtering.

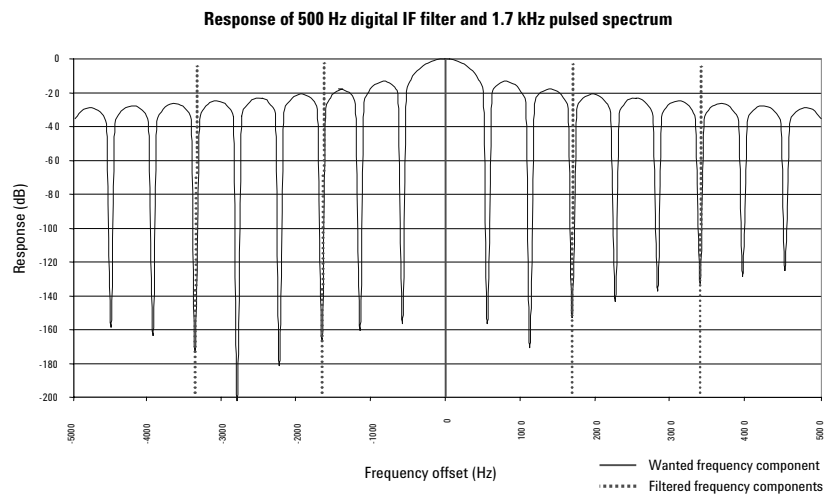

Figure 29. Zoomed-in view of spectral nulling with 500 Hz filter (PRF = 1.7 kHz)

If you chose a narrower bandwidth to improve measurement dynamic range (at the expense of measurement speed), the spectral components would skip more nulls. In this way, you can trade off dynamic range and measurement speed by varying the IF bandwidth.

Figure 30 shows what the nulling looks like when you narrow the IF filter bandwidth by a factor of 3, to 166 Hz. This example uses every ninth null of the filter, which represents an IF bandwidth that is about 9.9% of PRF, instead of the 0.1% to 1% required with conventional filtering. Narrowing the filter in this manner increases the dynamic range by about 5 dB ($10 \cdot \log [3]$).

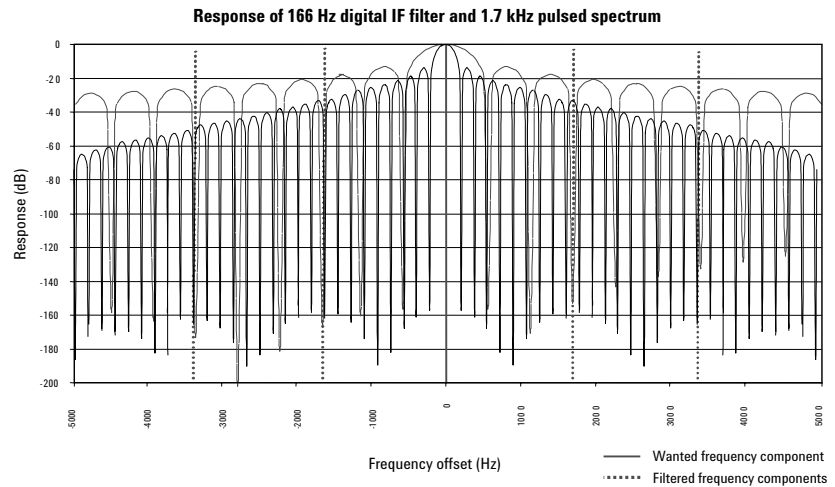

Figure 30. Zoomed-in view of spectral nulling with 166 Hz filter (PRF = 1.7 kHz)

Figure 31 illustrates the speed differences between two traces that both use narrowband detection. One trace uses the PNA's IF filters in a conventional manner, and the other trace utilizes the spectral nulling technique. If the standard filter bandwidth is too large, then large amounts of trace noise can be seen, as shown in the two left-hand plots. The right-hand plot shows that when both traces have approximately the same trace noise, spectral nulling results in a 14-fold improvement in measurement speed compared to using conventional filtering.

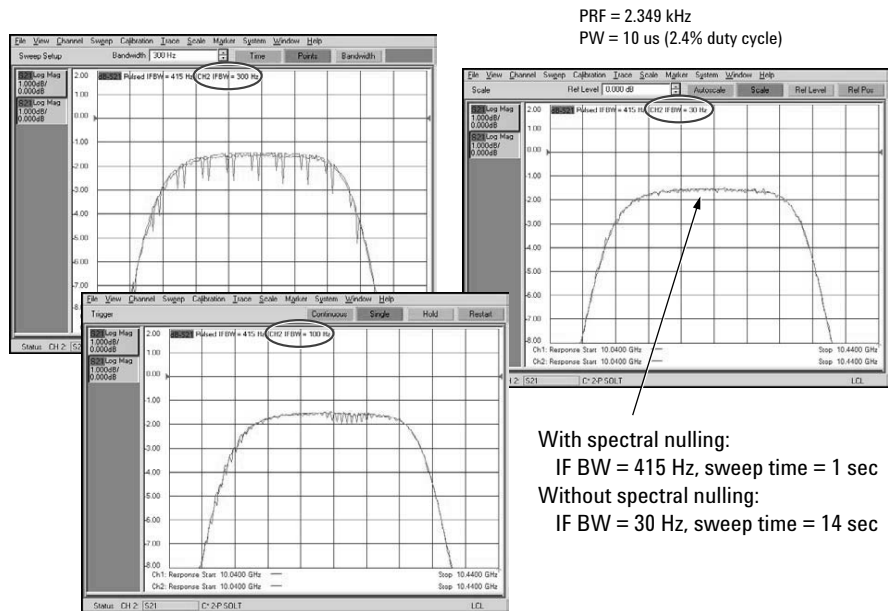
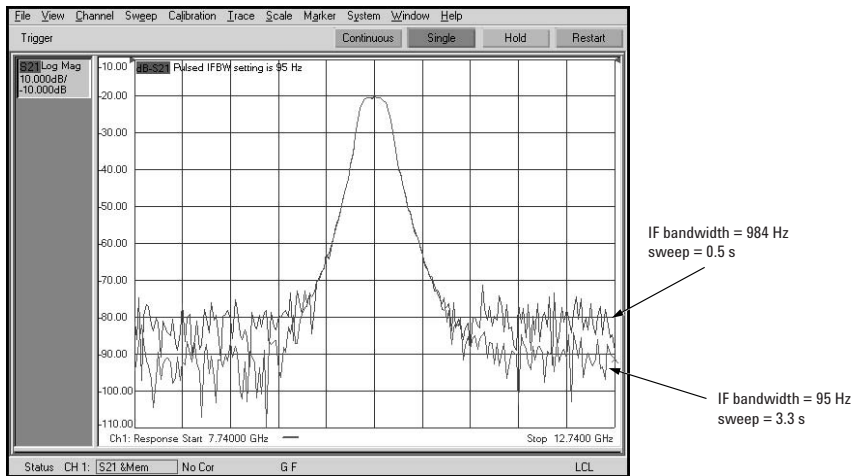

Figure 31. IF bandwidth comparison, conventional filtering versus spectral-nulling

Figure 32 demonstrates that decreasing the IF bandwidth of point-in-pulse measurements using narrowband detection results in more measurement dynamic range (and slower sweep times), as occurs during normal S-parameter measurements.



$$\Delta_{\text{noise}} = 10 \cdot \log(984/95) = 10.2 \text{ dB}$$

Figure 32. Dynamic-range comparison of two bandwidths using narrowband detection

The algorithm that PNA Option H08 uses to null unwanted spectral components also nulls (Figure 33) other sources of interfering signals such as:

- Aliased spectral components – for narrow pulses with broad frequency content, the unfiltered pulsed signal can wrap around the DC point in the analyzer’s receiver, and fold back on top of itself. Although the spacing of these folded signals is the same as the unaliased spectral components, the aliased components are unlikely to fall exactly on top of the unaliased components. They will appear as a new set of pulsed components that are offset in frequency from the unaliased spectrum.
- Baseband leakage – often in pulsed-RF systems, the baseband modulating signal leaks onto the pulsed-RF signal, causing another set of spectral lines that, in general, do not align with the main pulsed-RF spectrum. This leakage signal is often called “video feed-through”, an old term dating back to the early days of radar.
- Images – because of the two conversions used in the PNA to down-convert the incoming RF to an IF signal, image frequencies exist where the receivers have an undesirable response.

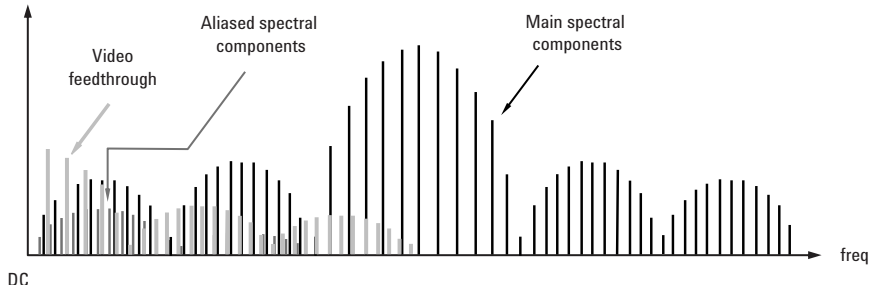

Figure 33. Elimination of additional interfering signals

All of these additional signals are nulled by selecting a narrower IF filter bandwidth than what would be needed to null just the main pulsed-RF spectrum. The narrower filter has more nulls that are more closely spaced in frequency, and these nulls can be used to cancel multiple sets of offset spectral components.

Spectral nulling can also be done without Option H08, by using one of the PNA's standard IF filters. The spacing between nulls can be calculated as $2 / [(\# \text{ taps} - 6) \times \text{sample-time}]$. However, the PRF must be exactly set to a multiple of the null spacings of the selected IF filter. This limits the flexibility of having arbitrary PRFs and in many cases will prevent measuring at a PRF specified by a system designer, or result in excessively slow measurement speed. In addition, it would be very difficult to null out all of the undesired spectral components shown in the previous figure. Using Option H08 allows the creation of "custom" IF bandwidth filters which provide better rejection of undesired signals while yielding full PRF flexibility, reducing trace noise and increasing dynamic range.

Figure 34 shows a picture of narrowband detection on the PNA, in the time domain. The bottom image shows the actual down-conversion chain in the PNA. The IF gate switches, which are used for point-in-pulse and pulse-profiling measurements to restrict the data acquisition to a specific region within the pulse, are placed in the 8.33 MHz first-IF path. The minimum pulse width that can be applied to these gates is 20 ns. A second down-conversion stage follows, producing the final IF of 41.7 kHz. An anti-alias filter is placed just in front of the ADC. The top waveform shows the incoming pulses, with a 1 us PW after gating, and a PRP of 100 us (1% duty cycle).

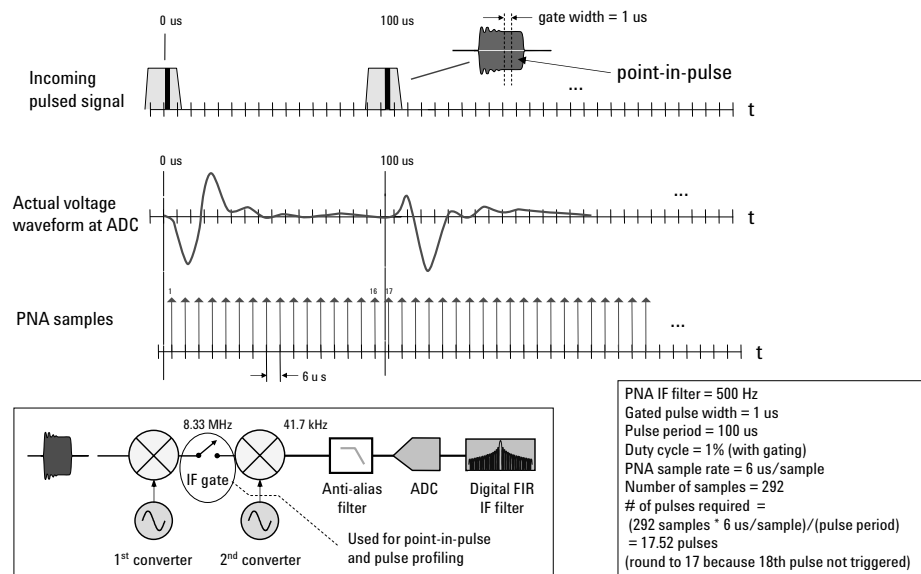

Figure 34. PNA narrowband detection in the time domain

The middle waveform is the actual voltage waveform at the input to the ADC, and it shows the pulses spread out by the anti-alias filter. In this example where the pulses are relatively narrow, this waveform represents the impulse response of the PNA's receiver. The lower waveform shows the sampling process, which occurs continuously, and is asynchronous to the incoming pulses. You can easily see that for small duty cycles, the impulse response falls into the noise before the next pulse appears. In this case, the ADC samples a lot of noise in-between pulses, which lowers the signal-to-noise ratio and decreases dynamic range. As the time between pulses is increased, more noise is sampled, further lowering the dynamic range.

Continuing with our example of a 500 Hz filter, 292 samples are required to produce one S-parameter trace point. At 6 us per sample, this takes 1.75 ms. With our PRP of 100 us, we see that 17 pulses occur for each trace point that we acquire. Under normal conditions, the magnitude and phase of the pulses (at a given carrier frequency) are time invariant, so we get consistent and repeatable results. If the pulse response changes during the course of a measurement at a particular carrier frequency, then the resulting trace point represents the average pulse response over the number of pulses used for that trace point. The number of pulses required for a single trace point varies according to the PRF and the IF bandwidth. Because multiple pulses occur for each trace point, narrowband point-in-pulse measurements require a hardware gate before the ADC.

Figure 35 shows that decreased dynamic range with decreased duty cycle can easily be observed on the network analyzer by measuring a device with high dynamic range, a highpass filter in this example. Although filters are not normally measured under pulsed conditions, they do serve as useful DUTs to demonstrate pulse de-sensitization effects.

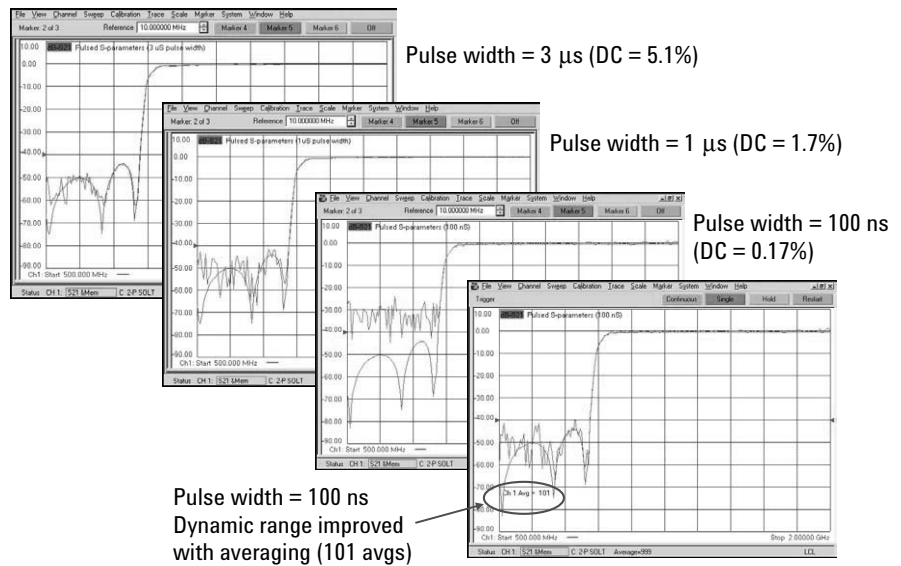

Figure 35. Duty-cycle versus dynamic range using narrowband detection and a high pass filter

In each plot, we compare a pulsed S-parameter (noisier trace) with a normal, swept-sinusoid S-parameter (cleaner trace). The top plot shows that with a 5% duty cycle, we can still measure the filter stopband to about -60 dB with reasonable accuracy. The next plot down (second from top), shows the effect of decreasing the duty cycle by a factor of three, resulting in a decrease in dynamic range of about 10 dB, and a rather noisy measurement of the filter's stopband. The next plot down (second from the bottom) shows that with another decrease in duty cycle (a factor of 10 this time), the analyzer's noise floor has increased by 20 dB, and is now above the filter stopband all together. Note that the PW is 100 ns in this example. The lowest plot shows that we can improve dynamic range by averaging. 100 averages results in a 20 dB improvement in dynamic range, so the measurement shows about the same dynamic range as the plot second from the top. For all of these examples, a unique calibration was performed for each set of pulse conditions.

Typical setup for forward pulsed-RF amplifier measurements

Figure 36 shows a typical PNA setup for making narrowband pulsed-RF measurements in the forward direction only, which often is all that is required for amplifier test. The example external test set is not just an RF modulator. It also includes an amplifier to boost the power of test port 1. Higher test-port power is often needed for radar components like transmit/receive (T/R) modules. The directional coupler is used to provide a reference signal after the booster amplifier, so any drift of the booster amp is removed from the measurement by ratioing. The test set is connected to the PNA via the front-panel RF jumpers provided by Option 014. For other applications, a simpler test set consisting solely of one or two RF modulators (switches) could also be used.

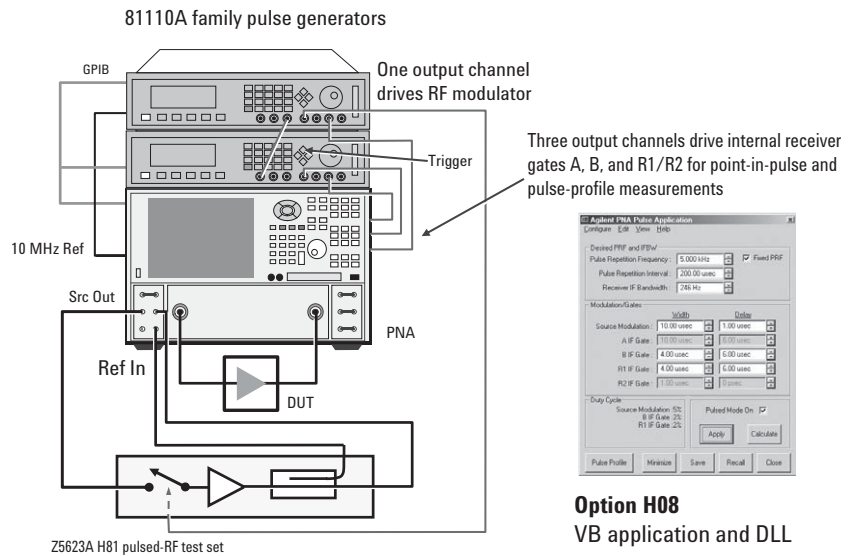

Figure 36. Typical PNA hardware setup for narrowband detection

The pulse generators, each with two output modules, provide the pulse timing to control the modulator and the PNA's internal receiver gates, which are used for point-in-pulse and pulse-profile measurements. Typically, four pulse outputs are used: one each for the RF modulator, A-receiver gate and B-receiver gate, plus one for the two reference-receiver gates, which can be tied together using a BNC tee. More complicated systems might require more pulse output modules. The pulse generators are controlled via GPIB, and the master pulse generator must be locked to the PNA's 10 MHz timebase. The second (slave) pulse generator is synchronized via a front-panel trigger signal. The overall system (PNA and pulse generators) is controlled by the PNA Pulsed Application software (Option H08).

Figure 37 shows all of the PNA hardware options associated with a typical narrowband pulsed-RF setup:

- 014 – Configurable test set
- UNL – Source attenuators
- 080 – Frequency-offset mode
- 081 – Reference switch
- H11 – IF access
- 016 – Receiver attenuators (optional)

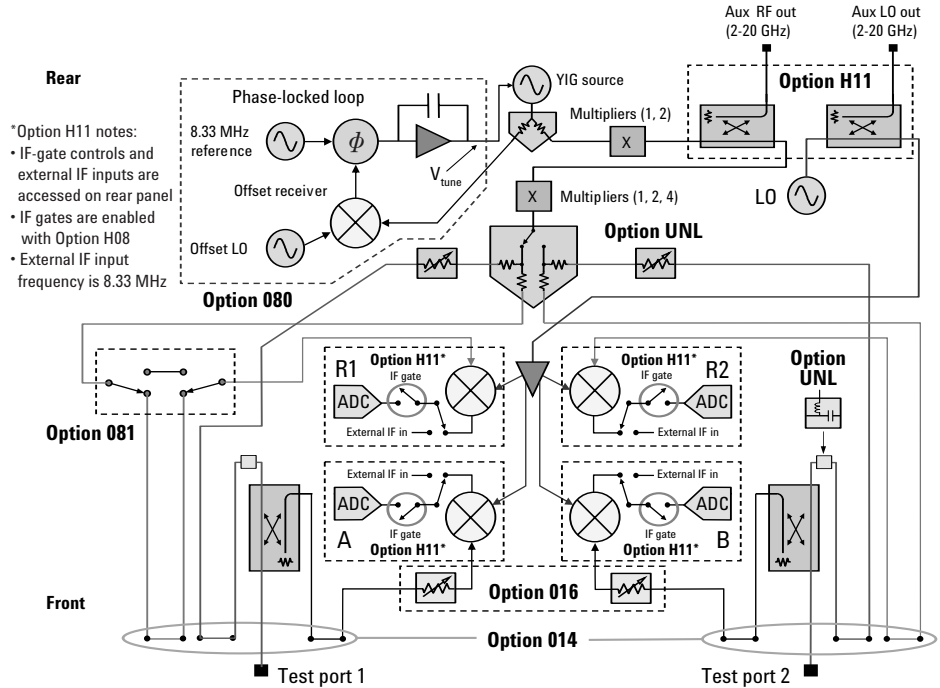

Figure 37. Typical PNA hardware options for narrowband detection

Option H11 adds the IF gating switches necessary for point-in-pulse and pulse-profile measurements. For a PNA configured with Option H11, Option 016 is the only “optional” option – all of the other options are required. Note that although the PNA uses dual-conversion receivers, only one conversion is shown for simplicity. Option H11 also adds external IF inputs and auxiliary RF and LO outputs. This additional hardware is necessary for antenna and mm-wave applications.

The IF gates supplied with Option H11 can only be used with Option H08. Option H08 also includes the proprietary algorithms that implement the spectral nulling technique used with narrowband detection. In addition, Option H08 controls the pulse generator(s) used in the system, and performs pulse-profile measurements.

Pulling it all together with Option H08

Option H08 comes with two software components. One is a dynamic-link library (DLL) which acts as a “sub-routine”, and is needed for manual and automated environments. The second portion is a Visual Basic (VB) application that runs on the PNA. This VB application is used for stand-alone, bench-top use. It interacts with the DLL and sends appropriate commands to the PNA and the pulse generator(s). The VB application is assigned to one of the PNA’s macro keys for easy access.

Figure 38 shows how Option H08 operates in the “software domain”. In stand-alone operation (indicated by the solid arrows), the VB application interacts with the DLL to get the necessary spectral-nulling parameters. The VB application then sends these values to the PNA. The application also controls the pulse generators. The VB application does not have an application-programming interface (API), so in a remote environment where the user has their own software to control the pulse measurements, the user software cannot interact directly with the VB application. Instead, the user’s software must call the DLL, and the returned values must then be sent to the PNA. The software must also directly program the pulse generators. Remote operation is indicated by the dashed arrows.

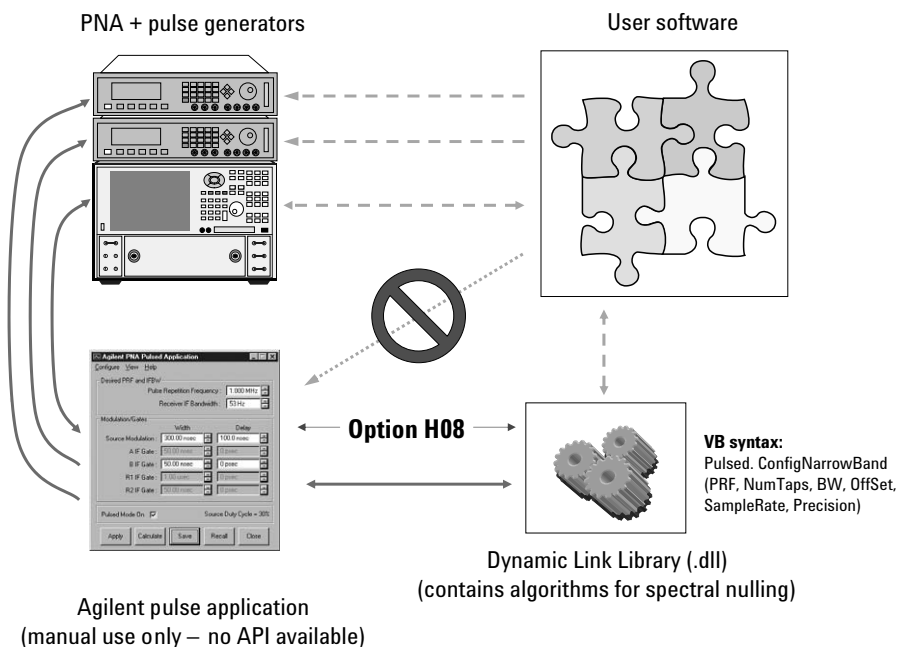

Figure 38. Option H08 in the “software domain”

While the H08 application supports manual pulse profiling with the ability to save data, it does not support remote (software-controlled) pulse profiling. This can easily be accomplished however with a small amount of program code (Figure 39). Basically, the delay of the pulse generator output(s) that controls the IF gate(s) for the signal or parameter you wish to profile is/are stepped in delay across a predetermined start and stop delay. At each delay, the PNA is triggered via software to make a single receiver or ratioed receiver (S-parameter) measurement. This is done in a loop. Agilent includes a Visual Basic programming example in the H08 documentation to demonstrate automated pulse-profile measurements.

Note

Option H08 uses the frequency-offset option (Option 080) to ensure the PNA remains phase-locked with a pulsed reference signal. However, the frequency-offset value is not always zero Hz — sometimes, the application uses a frequency offset of 1.389 kHz to compensate for an internal data-acquisition sampling-frequency shift. When this occurs and you try to set the PNA to its maximum stop frequency, an error will occur that says “Response frequencies exceed instrument range”. To prevent this from occurring, set the stop frequency to a value that is at least 2 kHz less than the maximum allowed. For example, on a 20 GHz PNA, set the stop frequency to 19.999998 GHz or less.

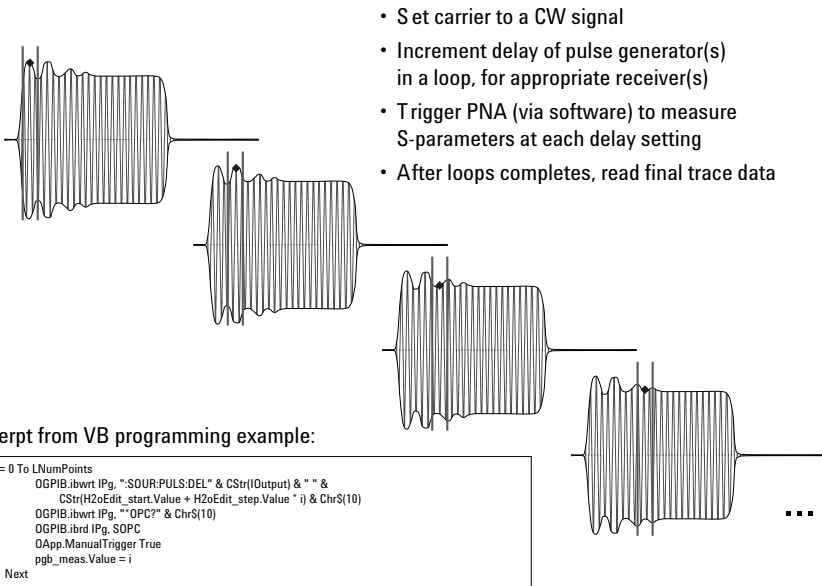

Figure 39. Pulse profiling with user software

Most narrowband pulse applications for the PNA will require a combination of Option H11 and Option H08. For cost-sensitive applications, a PNA without either option can be used, with limited flexibility and perhaps increased trace noise and degraded dynamic range due to sub-optimal spectral nulling. Option H08 can be used without H11 if average pulse measurements are sufficient (i.e., no point-in-pulse measurements), or if external RF switches are used in place of the internal IF switches for point-in-pulse and pulse-profile measurements.

More Configuration Choices

Hardware setups

Up to now, this application note has focused on two typical hardware setups, one each for wideband and narrowband detection. However, the PNA and PNA-L can be configured in other ways for other pulsed-RF applications. The following examples illustrate the flexibility of the PNA and PNA-L platforms. Note that some signal lines have been omitted for clarity, such as 10 MHz references, pulse-generator-to-pulse-generator triggers, and GPIB connections. Also, more pulse generators than shown can be utilized for increased flexibility of triggering the IF or RF gates when using narrowband detection.

Figure 40 shows an external RF switch used for receiver gating, instead of using the PNA's internal IF gate switches. This setup, only used with narrowband detection, can provide shorter gate widths (< 20 ns) than those obtained using the internal IF gates. This results in better timing resolution and lets you use a PNA without Option H11. For forward, ratioed, pulse-profile measurements with coupled gates, a second RF switch would be needed for the R1 reference channel.

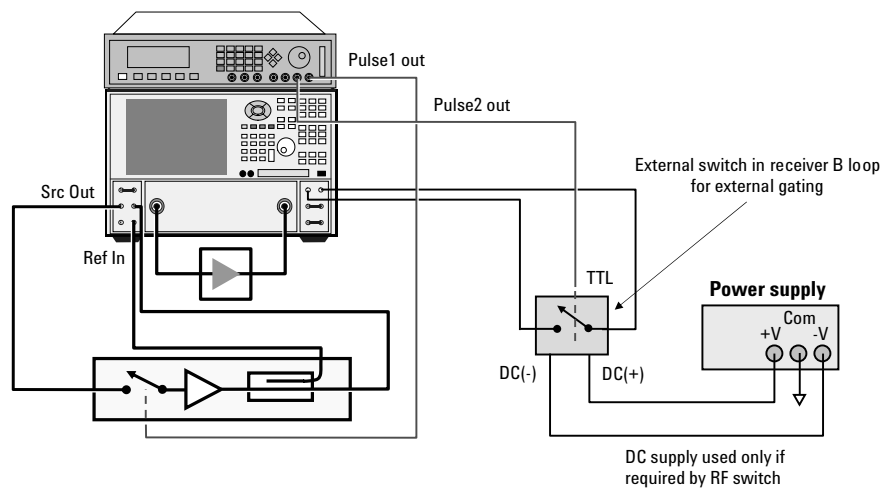

Figure 40. Using an external RF switch for receiver gating (for narrowband detection)

Figure 41 shows a setup for forward and reverse (bi-directional) pulsed-RF S-parameter measurements. This requires two RF switches for the modulators, and may or may not require the booster amplifiers and directional couplers shown in the figure. This configuration can be used with either wideband or narrowband detection. Note that when using narrowband detection with this setup, the forward and reverse modulators and the R1 and R2 reference receiver gates share two pulse drives. If independent control of the RF modulators and R1 and R2 receiver is desired for full flexibility, then six pulse output modules are needed, requiring a third pulse generator.

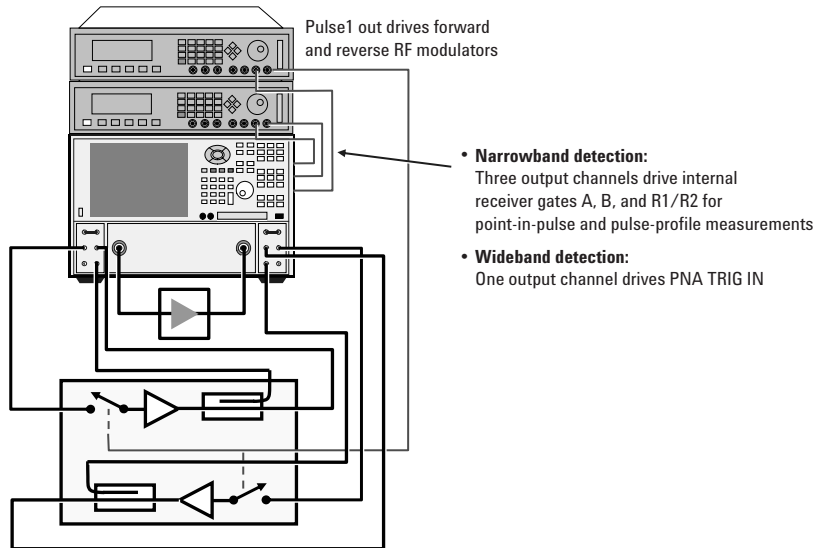

Figure 41. Forward and reverse (bi-directional) pulsed-RF S-parameter configuration

Figure 42 shows the PNA used with a pulsed RF signal created by pulsing the DC bias of the DUT. In this example, the input to the DUT is a swept CW signal, but the output is a swept pulsed-RF signal. The user has to supply the switches in the DC path of the amplifier, or use a power supply that can be pulsed on and off. This configuration can be used with wideband or narrowband detection. The setup is often used with wideband detection to test output amplifiers of GSM mobile handsets.

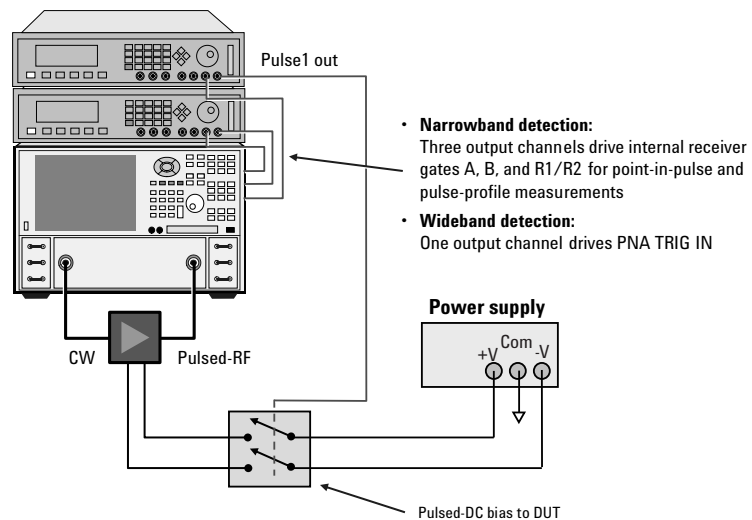

Figure 42. Pulsed-bias S-parameter configuration

Figure 43 shows the combination of a pulsed-RF stimulus with pulsed-bias. This is a common configuration for on-wafer device test. Although this configuration can be used for on-wafer measurements with wideband or narrowband detection, very narrow pulse widths are typically used, requiring narrowband detection. Note that when using narrowband detection with this example, three pulse drives are used for the A, B and combined R1/R2 IF gates. If independent control of all of the receiver gates is desired for full flexibility, then six pulse output modules are needed, requiring a third pulse generator.

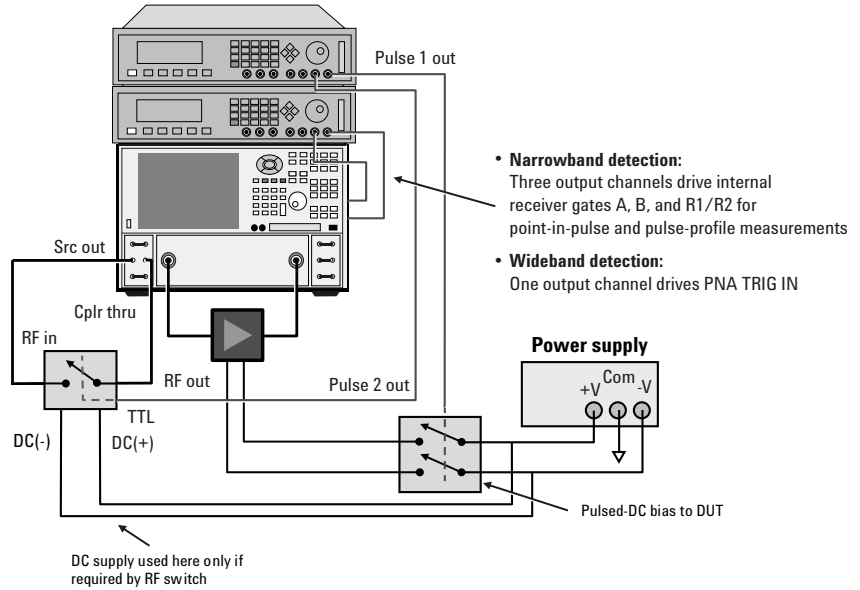

Figure 43. Pulsed-RF and pulsed-bias S-parameter configuration

Reference signal choices

There are four ways in which the reference receiver can be used for pulsed S-parameter measurements (Figure 44). A non-gated, CW stimulus (Figure 44a) gives the best dynamic range as no pulse desensitization occurs in the reference channel, but the effect of the pulsed stimulus is not ratioed out of measurements of the DUT. For example, if the pulse duty cycle changes, the uncorrected S-parameter will change, since the test receiver experiences a change in amplitude due to pulse desensitization, but the reference receiver does not. For most pulsed-RF S-parameter measurements, a pulsed signal for the reference receiver is recommended (Figure 44b, 44d). Furthermore, gating all four receivers of the PNA is recommended (Figure 44d), as this allows use of unknown-through calibrations (i.e., short-open-load-reciprocal thru, or SOLR).

Pulse-profile measurements show the time-domain response of the pulse. For these measurements, the reference receiver needs the pulsed stimulus so that the resulting profile truly measures the effect of the DUT on the pulse's magnitude and phase, without the pulse's inherent response affecting the results. Gating of the reference receivers is generally required for pulse-profile measurements (Figure 44d).

The configuration shown in Figure 44c is often used for a pulsed-DC-bias system with CW input.

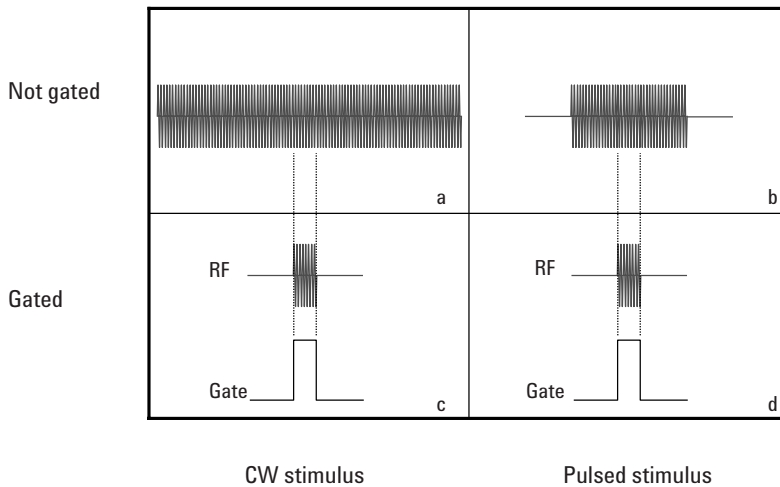

Figure 44. Reference signal choices

Pulse test sets

Agilent can supply a variety of test sets for pulsed S-parameter measurements. Test sets include a single pulse modulator at a minimum, but may also include additional modulators, booster amplifiers, directional couplers, switches, and so on. The Z5623A H81 2-20 GHz RF modulator gives the PNA pulsed-RF system similar capability to the 85108 in terms of frequency range and output power levels. With only one modulator, pulsed S-parameters can be done in the forward direction only, which is typical for amplifier measurements. Note that there are front-panel jumpers on the test set to bypass the internal amplifier or to substitute higher-power amplifiers. Agilent can supply other RF modulators as needed to fulfill the testing requirements of many applications, through its Component Test "Special Handling" group. For example, other applications might require higher frequency ranges, different internal amplifiers, or two modulators for forward and reverse pulsed S-parameters. These test sets are quoted on an individual basis. Some example of other test sets that have been previously supplied by Agilent are:

Z5623A H83	2-20 GHz Bidirectional (two pin switches), no amplifier
Z5623A H84	2-40 GHz Bidirectional (two pin switches), no amplifier
Z5623A H86	2-40 GHz Unidirectional, no amplifier

Figure 45 shows the Z5623A H83 2-20 GHz test set in more detail. This test set is often used for testing transmit/receive (T/R) modules used in phased-array radar systems. It includes two PIN switches for bi-directional (forward and reverse) pulsed-RF stimulus, and two directional couplers for the reference channels. It does not include internal amplifiers, but has provisions for switching in external amplifiers to boost port power in both directions.

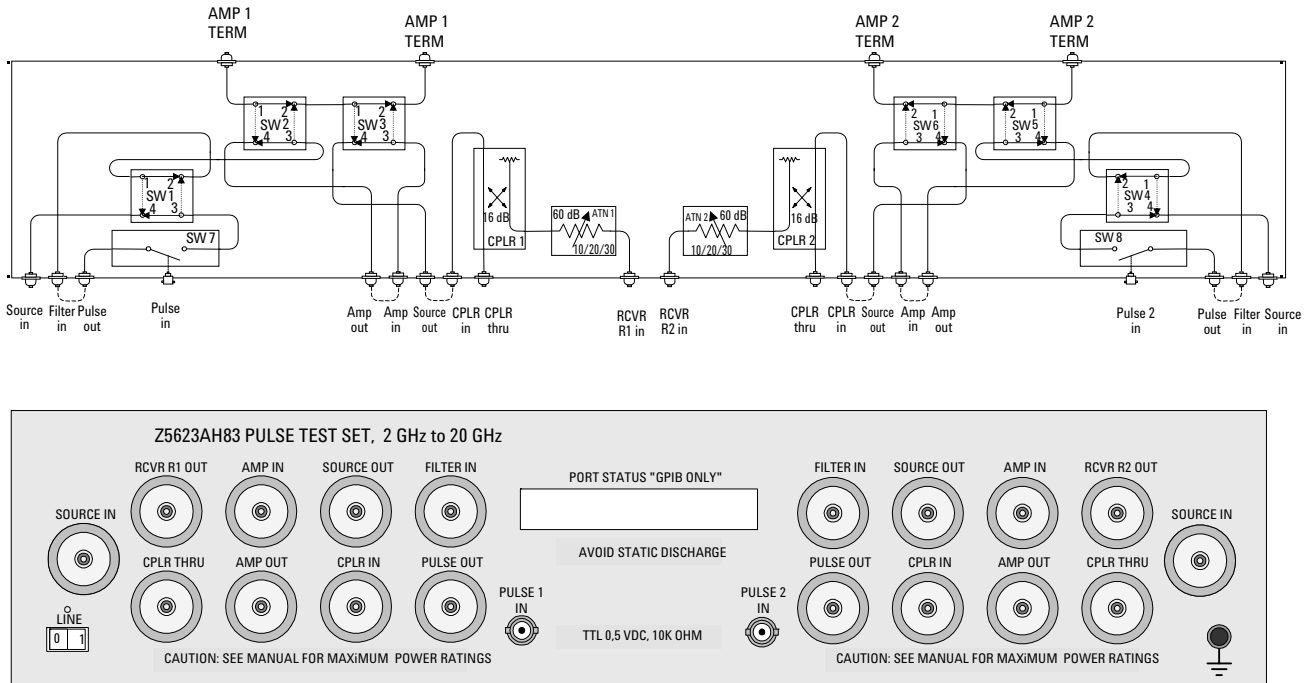

Figure 45. Z5623A H83 2-20 GHz test set for bi-directional pulsed S-parameters

Pulse generators

Pulsed S-parameter measurements require one or more external pulse generator. Agilent 81100 series pulse generators are recommended as they can be controlled with Option H08. At least one pulse generator must have a 10 MHz reference to lock to the PNA. This pulse generator is the master. The remainder of the pulse generators (if any) are triggered by the master. Agilent 81100 series pulse generators can have one or two output modules. The number of output modules depends on the desired measurements. The minimum number of output modules required is one, to control the RF modulator. For point-in-pulse and pulse-profile measurements, other modules are needed to control the internal IF or external RF gates. Note that gates can share a common output module if the same pulse width and delay can be applied to two or more receivers. The table below summarizes the number of output modules and pulse generators required for independent gate control for various point-in-pulse S-parameter measurements. If independent control of forward and reverse modulators is desired in addition to all four pulsed S-parameters, then six output modules are required (3 pulse generators). Two common setups shown in Figures 36 and 41 and on row 5 of the table are configured to have the R1 and R2 reference receivers share a common pulse output. This allows independent delay and width control for the A and B gates using only two dual-output pulse generators.

Output modules required	Pulse generators required	Output module usage for independent control	Point-in-pulse measurements available
2	1	RF modulator, B gate	S21 with <i>ungated</i> reference
3	2	RF modulator, A and B gates	S11, S21 with <i>ungated</i> reference
3	2	RF modulator, R1 and B gates	S21 with <i>gated</i> reference
4	2	RF modulator, R1, A and B gates	S11, S21 with <i>gated</i> reference
4	2	RF modulators, R1/R2 (shared), A and B gates	S11, S21, S12, S22 with <i>gated</i> references
5	3	RF modulators, R1, R2, A and B gates	S11, S21, S12, S22 with <i>gated</i> references
6	3	Fwd. RF modulator, rev. RF modulator, R1, R2, A and B gates	S11, S21, S12, S22 with <i>gated</i> references

IF gain setting

For normal S-parameter measurements, PNAs (and some PNA-L models) have an IF automatic-gain-control feature that maximizes measurement dynamic range. For pulsed-RF measurements, this “auto” mode should be disabled. Option H08, used for narrowband measurements, does this automatically, but when using wideband detection (or narrowband detection without Option H08), the user must turn off the “auto” mode and set the gain of each receiver manually. This decreases the pulse-settling time of the PNA significantly. With the auto gain on, the settling time of the PNA is around 100 us; with it off the settling time drops to about 20 us. To turn off the “auto” mode, select the **Channel** menu > **Advanced** > **IF Gain Configuration**, and unselect the **Automatic** checkbox. In most cases, the gains of the receivers should be set to **Low** or **Med**, depending on the signal levels involved. The proper gain settings can be determined by empirical observation of the S-parameter measurements; ensure that receiver compression effects are eliminated or minimized to acceptable levels.

Reference loop

If your PNA has Option 081 (a reference-receiver switch) and you are using a pulse setup that routes some of the pulsed stimulus back to the PNA's reference receiver, be sure that the R1 input path is set to external. If not, the PNA will use the internal CW source as the reference, and any external signal-conditioning components (couplers and amplifiers for example) will not get ratioed out of the measurement. To select the external reference path, select the **Channel** menu > **Test Set...** > **External: flow through R1 Loop**.

Measuring frequency converters

Pulsed measurements on mixers and converters using wideband or narrowband detection can be accomplished on the PNA using the Frequency Converter Application or FCA (Option 083) or by using the basic frequency-offset mode provided by Option 080. Compared to Option 080, Option 083 offers a simplified user setup plus advanced mixer calibrations for accurate conversion loss and absolute group delay measurements.

When using either Option 083 or 080, wideband detection can be set up as we have previously outlined in this application note. For narrowband detection using the H08 pulse application, a special mode of operation must be used that doesn't overwrite the frequency offset used in the channel by Option 083 or 080. This special converter mode is set by selecting the **Configure** menu in the H08 application (not the PNA's menu), then selecting the **Converter Measurements** choice (a check mark will appear). In this mode, the “Fixed PRF” choice should not be used. For point-in-pulse measurements, either Option 083 or 080 can be used. However, the pulse-profile feature only works with Option 080 and does not work with Option 083.

Using power sweeps

Power sweeps can be combined with either narrowband or wideband detection to measure gain compression and AM-to-PM conversion of mixers and converters. A source power calibration is recommended for improved accuracy. The procedure for performing a source power calibration is described in the next section.

Calibration

S-parameter measurements

Calibrating a pulsed-PNA system is essentially the same as calibrating a normal S-parameter measurement. Calibration can be done with both wideband and narrowband detection. Either mechanical or ECal modules may be used. The calibration should be done under pulsed conditions, and each unique set of pulse and gating parameters usually requires a separate calibration. ECal modules are especially useful for pulsed-RF measurements, because numerous measurement setups with unique pulse conditions can be calibrated with a single set of connections to the ECal module, making calibration fast and easy.

When using wideband detection, you must set up the proper delay value for the pulse acquisition trigger *before* doing a calibration to ensure that data is only taken during the "on" portion of the pulse.

Note that if you are using narrowband detection and are not gating all of the analyzer's receivers, the unknown thru method for SOLT calibrations might fail. With firmware revision A.06.xx or higher, you can specify the thru choice for both mechanical calibration kits and ECal modules, so you can easily select another thru method besides the unknown thru. Gating all of the receivers ensures that the unknown thru calibration works in all cases.

Source power calibration

Whenever accurate port power is desired, a source power calibration must be done. The procedure is a little more complicated for pulsed conditions, as the readings of the power meter are affected by the duty cycle of the pulsed-RF stimulus. Currently, the PNA only uses average power readings (from average or peak-power sensors) when performing a source power calibration. Therefore, under pulsed-RF stimulus, the power meter will read a value that is lower than the peak pulse power (defined as the power during the time the pulse is on) by $10 \cdot \log(\text{duty cycle})$. Note that since the power meter is measuring power and not voltage, the loss is $10 \cdot \log(\text{duty cycle})$ and not $20 \cdot \log(\text{duty cycle})$.

When calculating the desired calibrated source power value for the test port, remember that you are specifying average pulse power rather than peak pulse power. For example, if you want +10 dBm calibrated peak pulse power at the test port and the pulse duty cycle is 5%, then the PNA's calibrated port power should be $+10 \text{ dBm} + 10 \cdot \log(.05) = +10 + (-13) = -3 \text{ dBm}$.

In order to successfully perform a source power calibration, the power-offset feature must be used to ensure that the PNA's automatic level control (ALC) circuitry does not go unlevelled as it tries to bring the test port power to the desired calibrated power level. The value for power offset must compensate for any gain (from booster amps) or loss (from attenuators or pulse desensitization) that might be present in the system between the PNA's internal source and the test port. The pulse desensitization effect due to duty cycle appears as attenuation, since the power meter reads average pulse power rather than peak pulse power. When performing a source power calibration under pulsed conditions, use the following formula:

$$\text{Power offset (dB)} = \text{booster amplifier gain (dB)} + 10 \cdot \log(\text{duty cycle})$$

For example, if an amplifier with 25 dB gain was used, and the duty cycle of the pulsed-RF stimulus was 5%, then the power offset value should be set to $25 + 10 \cdot \log (.05) = 25 + (-13) = 12$ dB. If no booster amplifier was used, then the power offset value would just be -13 dB.

When calculating the duty cycle of narrowband measurements, do not include any reduction in duty cycle due to gating, as the gates only affect the PNA's receivers, and the power meter measures the un-gated pulsed stimulus.

Combining our example of +10 dBm calibrated peak pulse power with the example of a 25 dB booster amp and 5% duty cycle, you would initially set the source power on the PNA to -3 dBm $- 12$ dB = -15 dBm. Then, when performing the source power calibration with a power offset of 12 dB, the calibrated output power will be -3 dBm. Although the PNA will report its source power as -3 dBm, the actual peak power is -3 dBm $+ 13$ dB = $+10$ dBm.

Using the method described above, any inaccuracy in knowing the effective duty cycle will affect the calibrated output power of the PNA. Inaccuracies might be due to rise and fall times of the pulse being a significant portion of the pulse width. An empirical approach to measuring pulse desensitization (rather than calculating it from duty cycle) is to simply measure the difference in power of the RF stimulus between CW and pulsed conditions. This value can then be used to set average and peak power levels.

Comparing the PNA and 8510

The last section details the performance differences between the PNA and 8510 network analyzers

Figure 46 shows a comparison between the PNA, PNA-L, and the 8510. The 8510's dominant detection mode is wideband, due to its relatively large bandwidth (about 3 MHz before detection, 1.5 MHz for I and Q pulses after detection). The detection is done before the analog-to-digital conversion, and is achieved with analog circuitry. The detector consists of a synchronous down-converter which produces baseband I/Q outputs. Pulse profiling is achieved by varying the sample point along the baseband pulses. The only way to trade off speed and dynamic range with the 8510 is with averaging.

The PNA's dominant detection mode is narrowband, due to its relatively low bandwidth of 35 kHz. All filtering and detection is done after the analog-to-digital conversion, using digital-signal processing. Pulse profiling is achieved with analog switches that gate the IF (or RF) signals prior to filtering and detection. The PNA's narrowband mode trades off speed and dynamic range using variable IF bandwidths as well as averaging. The PNA can also do broadband detection with pulses as narrow as 50 us.

The PNA-L's dominant mode is wideband detection. All filtering and detection is done after the analog-to-digital conversion, using digital-signal processing. The widest IF bandwidths are 250 kHz (2-port 20, 40, 50 GHz models) or 600 kHz (2-port 6, 13.5 GHz and 4-port 20 GHz models) allowing point-in-pulse measurements of 10 us or 2 us respectively. Pulse profiling is similar to the 8510 except the sampling is done on IF pulses instead of baseband pulses. Normally, wideband detection is done at the widest IF bandwidth, so the only way to improve dynamic range is by averaging.

Although PNA, PNA-L, and 8510-based systems make measurements with different hardware and different types of detection, the resulting pulsed S-parameter and pulse-profile measurements are identical for a given device tested on any of the systems.

8510 (85108A)

- Dominant mode is wideband detection
- Detection is done BEFORE analog-to-digital conversion
- Analog synchronous detector produces baseband I/Q output (detector bandwidth = 1.5 MHz)
- Pulse profiling achieved by varying sample point of baseband pulses
- Trade off speed and dynamic range with averaging



PNA

- Dominant mode is narrowband detection
- All processing (filtering and detection) is done digitally
- Widest bandwidth = 35 kHz
- Pulse profiling achieved with analog switches that gate IF (or RF) signals
- Trade off speed and dynamic range with variable IF bandwidths and averaging



PNA-L

- Dominant mode is wideband detection
- All processing (filtering and detection) is done digitally
- Widest bandwidth = 250 or 600 kHz
- Pulse profiling achieved by varying sample point of IF pulses
- Trade off speed and dynamic range with averaging

Figure 46. Comparing the 8510, PNA, and PNA-L

Figure 47 shows the 85108A's dynamic range versus pulse width for various duty cycles. The data was taken using a constant time-per-point of 90 ms. In some 8510 cases, more averaging could be done in this time frame, resulting in increased dynamic range.

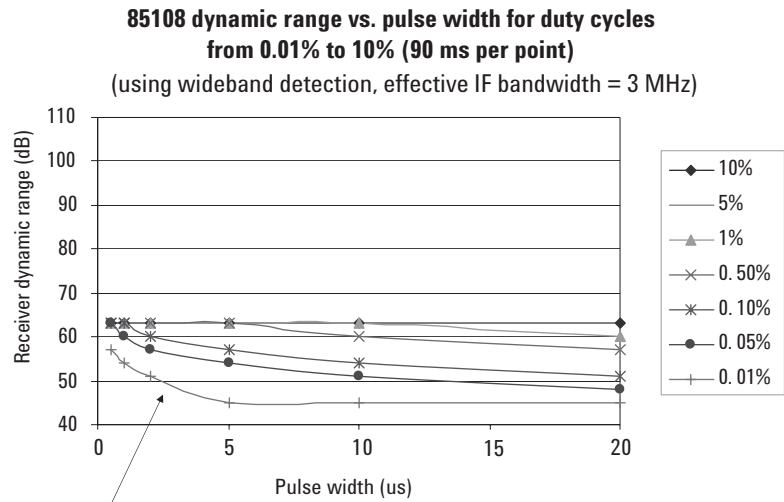

Number of averages increases to keep constant time-per-point

Figure 47. 85108A dynamic range versus pulse width for various duty cycles

Figure 48 shows the PNA's dynamic range versus pulse width for various duty cycles. The PNA's bandwidth was 10 Hz, to match the time-per-point of 90 ms used for the 85108A data.

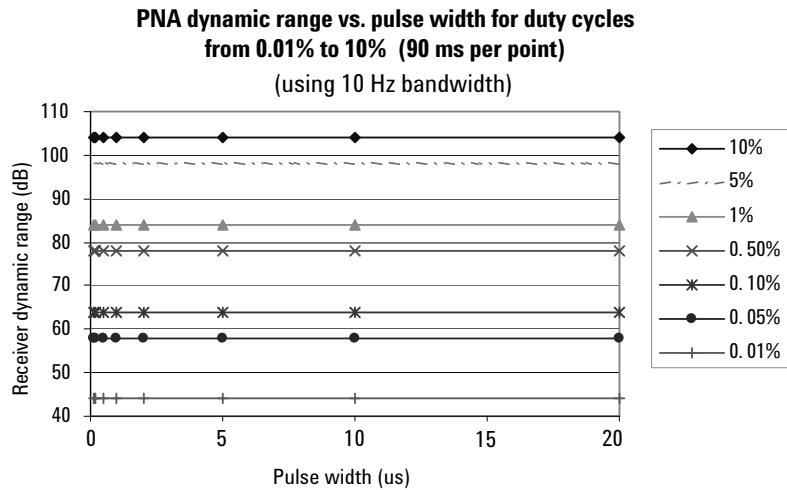

Figure 48. PNA dynamic range versus pulse width for various duty cycles

Figure 49 shows the actual dynamic range versus duty cycle, between the 8510 and PNA. The bandwidth of the PNA was chosen to give the same time-per-point as the 8510. The PNA's dynamic range varies with duty cycle, but the crossover point is at about 0.1% duty cycle. For most radar applications (duty cycles in the 1 to 10% range), the PNA has superior dynamic range compared to the 8510.

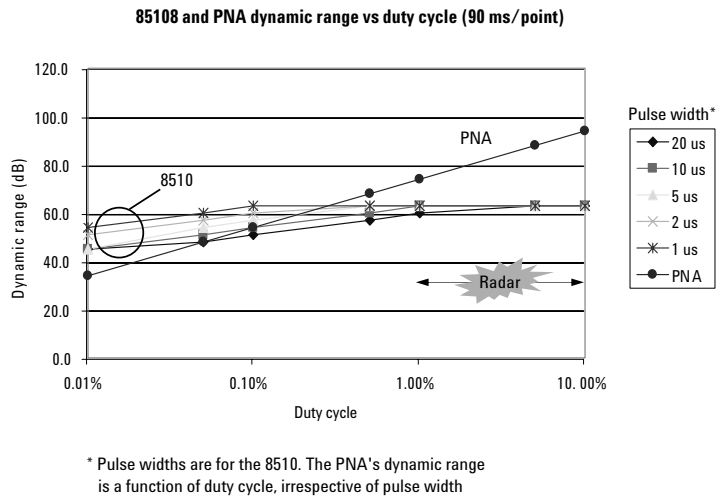

Figure 49. Comparing dynamic range of the PNA and 8510

Figure 50 shows an example point-in-pulse measurement of a bandpass filter. Although filters are not normally measured under pulse conditions, they are very useful to show the overall dynamic range of the test system. The pulse conditions used for this example were chosen because they are representative of a typical radar application. Note, there is excellent correlation between the PNA and 8510 in the passband and transition region of the filter. This example also shows that the PNA has about 10 dB better dynamic range, and sweeps 6 times faster than the 8510.

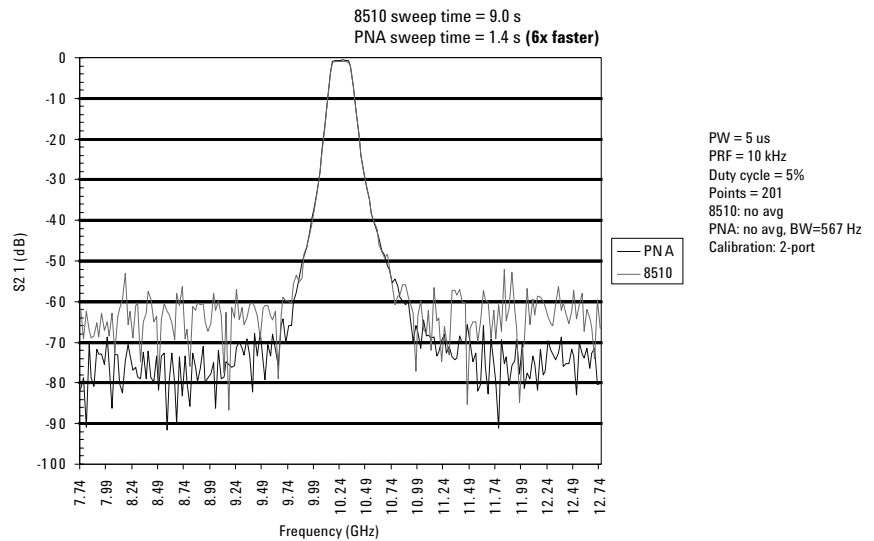

Figure 50. Example measurement comparison of PNA and 8510

Figure 51 is a review of some of the key issues we have covered in this application note. One thing to note is that the 8510's narrowband mode is limited to high PRF's (minimum PRF around 50 kHz to 100 kHz), and no spectral nulling is available.

	Wideband/synchronous	Narrowband/asynchronous
Advantages	Constant dynamic range	Narrow pulse widths
Disadvantages	Lower pulse width limit Elevated noise floor	Dynamic range loss with small duty cycles No pulse-to-pulse
8510	PW > 1 us	Limited*
PNA/PNA-L	PW > 50 us/10 us/2 us**	PW > 20 ns (limited by IF gate)
PNA options	None required	H11/H08***
Measurements	Average Point-in-pulse Pulse profile Pulse-to-pulse	Average Point-in-pulse Pulse profile

* Hi PRF, no nulling, no point-in-pulse

** PNA/PNA-L 2-port 20, 40, 50 GHz/PNA-L 2-port 6, 13.5, 4-port 20 GHz

*** Option H08 is usually used in conjunction with Option H11. Without H11, the user can perform average pulse, or point-in-pulse measurements using external RF gates.

Figure 51. Pulse summary

Summary

Testing with pulsed RF stimulus is very important for radar, electronic warfare and wireless communications systems. Modern network analyzers utilize two different detection schemes, each with advantages and disadvantages. Both wideband and narrowband detection can be used for point-in-pulse, and pulse-profile measurements. Pulse-to-pulse measurements require wideband detection. Although wideband detection has traditionally been the more widely used technique due to the popularity of pulsed 8510 systems, narrowband detection is a powerful alternative for analyzing pulsed-RF signals. Agilent's unique spectral nulling technique improves measurement speed considerably by using wider IF bandwidths. For radar and wireless communication applications, narrowband detection offers superior dynamic range and speed compared to the 8510. And with narrowband detection, there is no lower limit to pulse widths.

It is important to remember that although the PNA and PNA-L use different hardware and detection techniques than the 8510, the measurements and the measurement results are essentially the same – they both provide accurate pulsed-RF S-parameters.

In addition to providing high-quality pulsed-RF S-parameter measurements, the PNA and PNA-L offer many platform benefits. The PNA family has more measurement flexibility with 32 measurement channels, 128 traces, 16 windows, and up to 16,001 data points. The PNA family also offers all of the connectivity you'd expect from a PC-based instrument, such as connecting to printers via LAN, and using USB peripherals. Furthermore, the open Windows® environment allows maximum flexibility for automating measurements, like running software right on the instrument, and using COM and DCOM for fast program execution and data transfer. The PNA family also has many features to ease the task of vector network measurements, like a built-in HELP system, Calibration Wizards, and electronic calibration that works up to 67 GHz.

Web Resources

Pulsed-RF measurements:

www.agilent.com/find/pulsedrf

Aerospace & defense applications:

www.agilent.com/find/ad

PNA series network analyzers:

www.agilent.com/find/pna

Electronic calibration (ECal):

www.agilent.com/find/ecal

RF and microwave test accessories:

www.agilent.com/find/accessories



Agilent Email Updates

www.agilent.com/find/emailupdates

Get the latest information on the products and applications you select.



Agilent Direct

www.agilent.com/find/agilentdirect

Quickly choose and use your test equipment solutions with confidence.



www.agilent.com/find/open

Agilent Open simplifies the process of connecting and programming test systems to help engineers design, validate and manufacture electronic products. Agilent offers open connectivity for a broad range of system-ready instruments, open industry software, PC-standard I/O and global support, which are combined to more easily integrate test system development.

Remove all doubt

Our repair and calibration services will get your equipment back to you, performing like new, when promised. You will get full value out of your Agilent equipment throughout its lifetime. Your equipment will be serviced by Agilent-trained technicians using the latest factory calibration procedures, automated repair diagnostics and genuine parts. You will always have the utmost confidence in your measurements.

Agilent offers a wide range of additional expert test and measurement services for your equipment, including initial start-up assistance onsite education and training, as well as design, system integration, and project management.

For more information on repair and calibration services, go to:

www.agilent.com/find/removealldoubt

www.agilent.com

For more information on Agilent Technologies' products, applications or services, please contact your local Agilent office. The complete list is available at:

www.agilent.com/find/contactus

Phone or Fax

North America

Canada	(877) 894-4414
Latin America	305 269 7500
United States	(800) 829-4444

Asia Pacific

Australia	1 800 629 485
China	800 810 0189
Hong Kong	800 938 693
India	1 800 112 929
Japan	0120 (421) 345
Korea	080 769 0800
Malaysia	1 800 888 848
Singapore	1 800 375 8100
Taiwan	0800 047 866
Thailand	1 800 226 008

Europe

Austria	0820 87 44 11
Belgium	32 (0) 2 404 93 40
Denmark	45 70 13 15 15
Finland	358 (0) 10 855 2100
France	0825 010 700*
Germany	*0.125 fixed network rates 01805 24 6333** **0.14/minute
Ireland	1890 924 204
Israel	972-3-9288-504/544
Italy	39 02 92 60 8484
Netherlands	31 (0) 20 547 2111
Spain	34 (91) 631 3300
Sweden	0200-88 22 55
Switzerland (French)	41 (21) 8113811 (Opt 2)
Switzerland (German)	0800 80 53 53 (Opt 1)
United Kingdom	44 (0) 118 9276201

Other European Countries:

www.agilent.com/find/contactus

Revised: March 24, 2007

Product specifications and descriptions in this document subject to change without notice.

© Agilent Technologies, Inc. 2006, 2007
Printed in USA, November 28, 2007
5989-4839EN

Windows® is a U.S. registered trademark of the Microsoft Corporation.



Agilent Technologies